



Comfort, Care & Trust

Ophthalmic Instruments

 **SCHULTZ MEDICAL™**
THE SINGLE-USE INSTRUMENT COMPANY

Chapter #	Description	Page
56	VARIOUS EYE INSTRUMENTS	3 - 8
56	CURETTES / SPATULAS	9
56	KNIVES & SPUDS & PUNCH	10
56	CHOPPER & MANIPULATORS	11
56	BLADES HANDLES	12
56	RETRACTORS	13
56	LASIK	14 - 19
56	SPATULAS / CHOPPER	20 - 21
56	SPATULAS / MANIPULATORS	22 - 23
56	LENS LOOP	24 - 25
56	SPOON / HOOKS	26
56	HOOKS / MANIPULATORS	27
56	HOOKS / FIXATION RINGS	28
56	FIXATION RINGS	29
56	MUSCLE HOOKS	30 - 31
56	MUSCLE HOOKS / CORNEAL MARKERS	32
56	CORNEAL MARKERS	33 -34
56	EYE SPECULA	35 - 39
56	PUNCHES	40
56	FORCEPS / FRAZIER	41
56	FORCEPS	42 - 43
56	NEEDLE HOLDERS	44 - 49
56	LACRIMAL INSTRUMENTS	50 - 54
56	CANNULAS	55 - 60
56	MICRO NEEDLE HOLDER	61 - 63
56	MICRO NEEDLE HOLDER WITH TC	64
56	RAZOR BLADE BREAKERS	65
56	SCISSORS	66 - 69
56	SCISSORS SPRING ACTION	70 - 78
56	IRIS FORCEPS	79 - 120



**OPHTHALMIC
INSTRUMENTS**

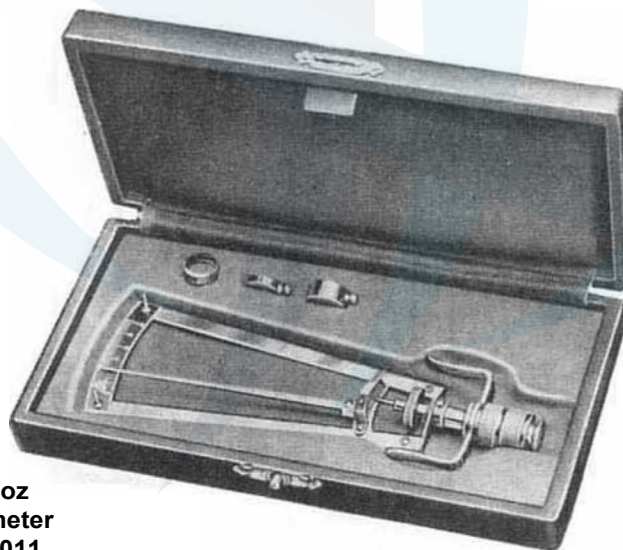
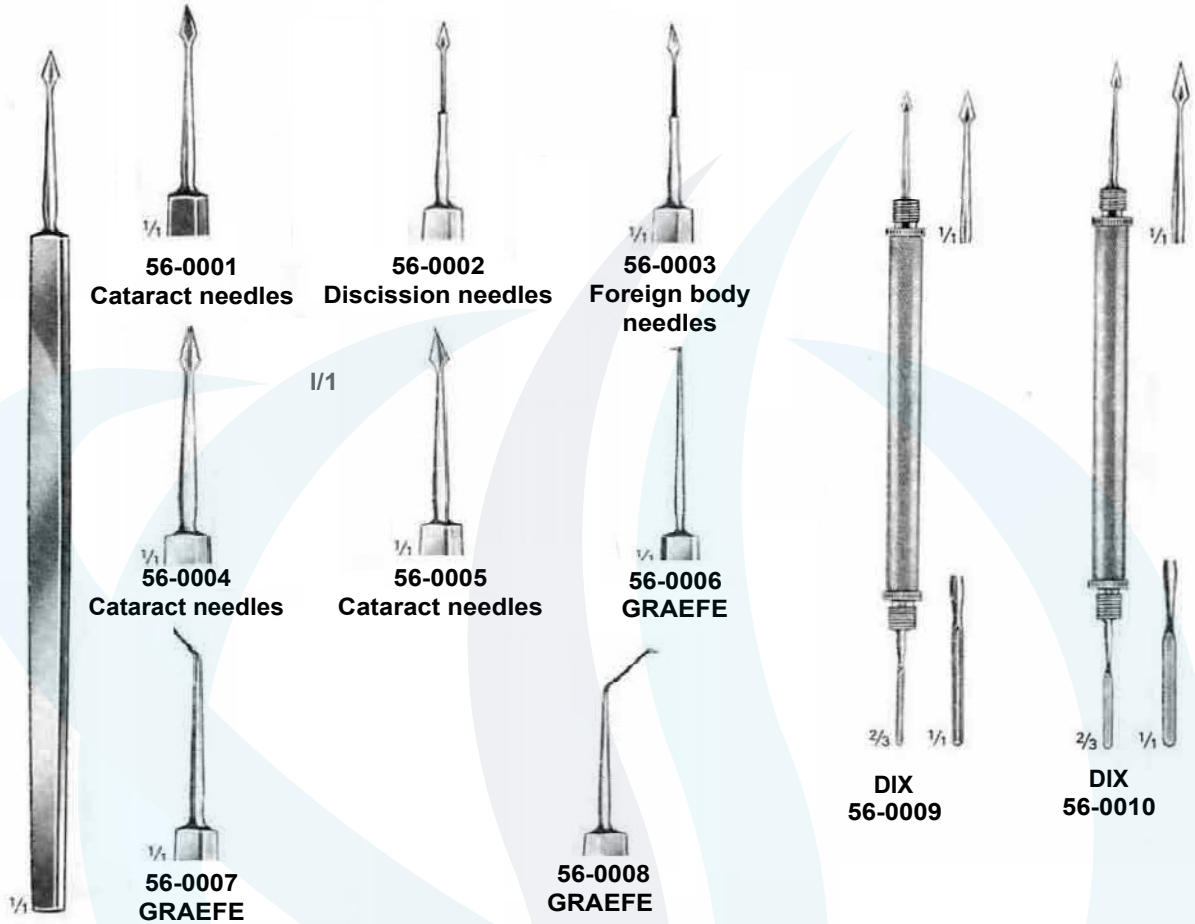

Schioz
Tonometer
56-0011

56



56-0012
JAMESON
CALIPER



CASTROVIEJO
56-0013
Scleral Caliper

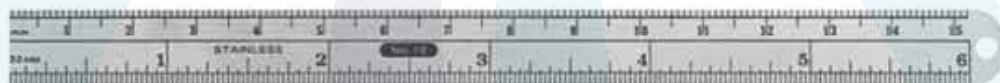

56-0014
RULER
STAINLESS STEEL



56-0015
WRIGHT
1MM X 6MM
14 CM LONG

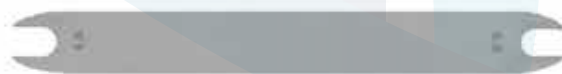

56-0016
BRAUNSTEIN
CALIPER
4.0MM



56-0017
BRAUNSTEIN
CALIPER
3.5 MM

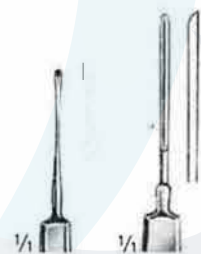

56-0018 **56-0019**
ELLIS **MEYER**



56-0020
ALVIS
Foreign Body
Instruments

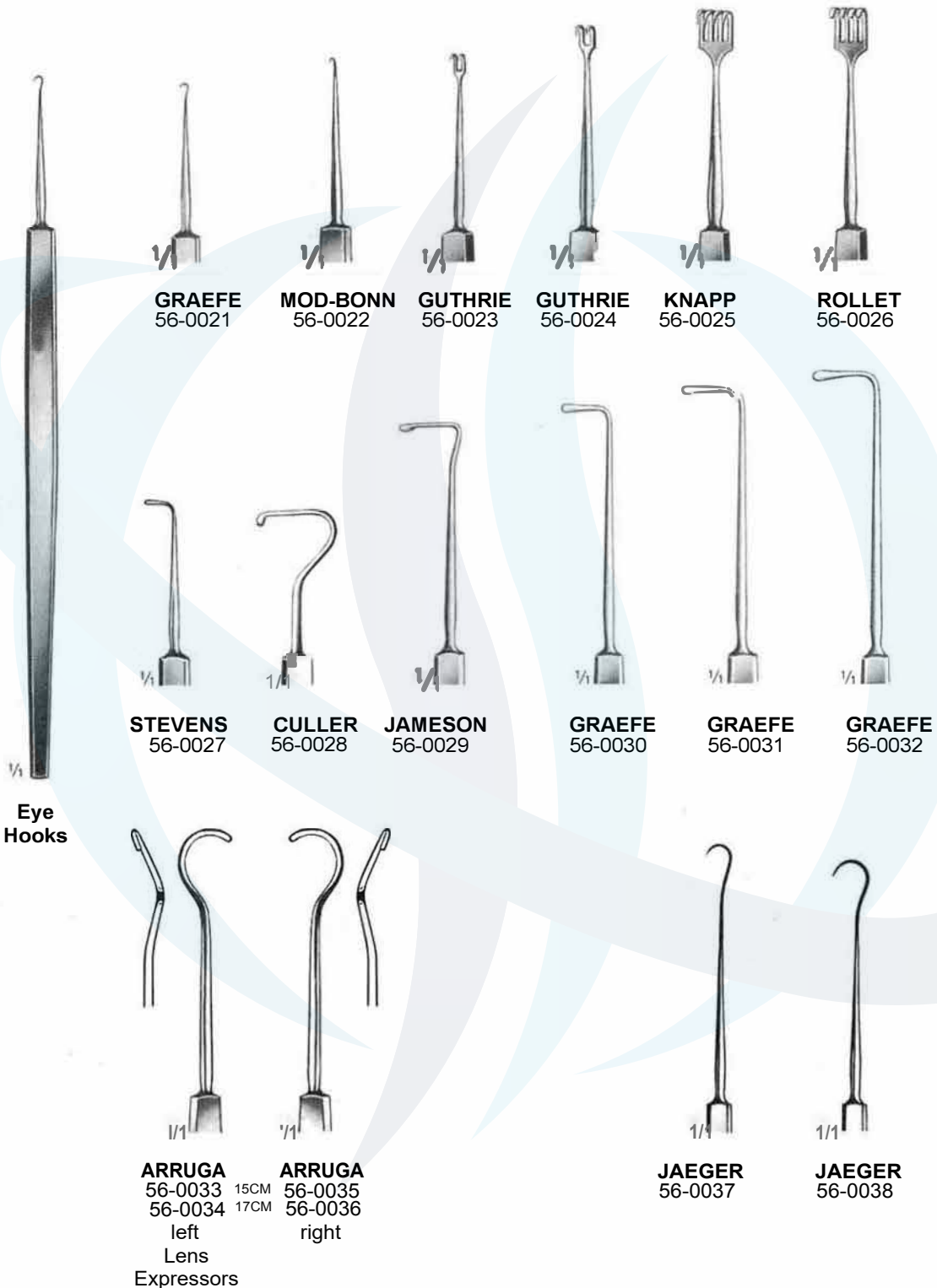

VARIOUS EYE INSTRUMENTS

Instruments oculaires divers

Varios instrumentos oculares

Verschiedene Augeninstrumente



SCHULTZ MEDICAL™

56



Fig. 1
56-0039



Fig. 2
56-0040



Fig. 3
56-0041



Fig. 4
56-0042



Fig. 5
56-0043



Fig. 6
56-0044



Fig. 7
56-0045



Fig. 8
56-0046



Fig. 9
56-0047



Fig. 10
56-0048



Fig. 11
56-0049



Fig. 12
56-0050



Fig. 0
56-0051



Fig. 1
56-0052



Fig. 2
56-0053



Fig. 3
56-0054



Fig. 4
56-0055



Fig. 5
56-0056



GRAEFE
14.0CM



CASTROVIEJO
56-0057
Keratome



Fig. 1
56-0058



Fig. 2
56-0059



Fig. 3
56-0060

Canaliculus knives



TOOK
56-0061
Corneal Knife



BARKAN
56-0062
Goniotomy Knife



GRAEFE
56-0063
Scarifier



Fig. 1
56-0064



Fig. 2
56-0065



Fig. 3
56-0066



Fig. 4
56-0067

GRAEFEE ZIEGLER IRIS KNIFE



DEUTSCHMAN
56-0068
Cataract Knife

VARIOUS EYE INSTRUMENTS

Instruments oculaires divers

Varios instrumentos oculares

Verschiedene Augeninstrumente



SCHULTZ MEDICAL™

56



JAEGER
56-0069
Lid Plate



DESMARRES
13cm/5"
Lid Retractors



12mm
56-0070



14mm
56-0071



16 mm
56-0072

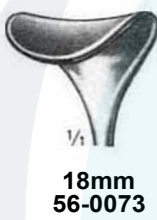

18mm
56-0073



2/3



Fig 1
KUHN
56-0074



Fig 2
KUHN
56-0075



Fig 3
KUHN
56-0076



MEYHOEFER
13 CM/ 5"
Chalazion
Curette



mm0 0,5
56-0077



1,0
56-0078



1,5
56-0079



1,8
56-0080



mm 2,0
56-0081



2,5
56-0082



3,5
56-0083



4,0
56-0084



4,5
56-0085



**56-0086
BARRAQUER IRIS
SPATULA ROUND
& SMOOTH**



**56-0087
CAPSULE
POLISHING CURETTE
1.75MM DIAMETER**



**56-0088
CULLER
IRIS SPATULA 2.0MM**



**DOUBLE ENDED CURETTE
56-0090 1.5 MM / 2.5 MM DIAMETER
56-0091 2.0 MM / 3.0 MM DIAMETER
56-0092 2.5 MM / 3.5 MM DIAMETER**



**56-0089
WHEELER
DOUBLE ENDED
SPATULA**

56



TOOKE
56-0093
CORNEAL KNIFE
STRAIGHT
BLADE



GILL
56-0094
CORNEAL KNIFE
CURVED
CUTTING EDGE



FUKASAKU
56-0095
HOCKEY KNIFE



FOREIGN BODY SPUDS
56-0096 GOLF CLUB
56-0097 FLAG SHAPED
56-0098 ROUND TIP



FUKASAKU
56-0099 0.6MM DIAMETER
HEAD BULLET SHAPED TIP



56



**56-0100
NUCLEUS
MANIPULATORS & HOOKS**

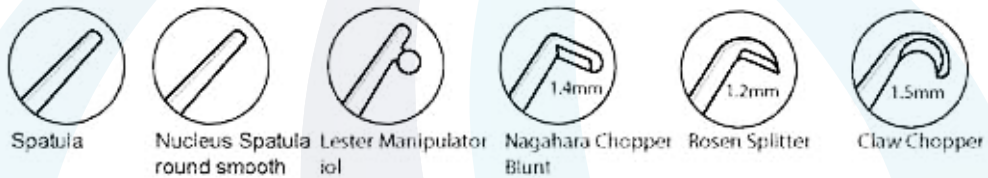

**56-0101
CHOPPERS &
MANIPULATORS**



Phaco Chopper/Mushroom Sinskey Hook / Phaco Chopper



**56-0102
DOUBLE
ENDED**



**56-0103
LENS LOOP
&
MUSCLE HOOK**

56



**BARD-PARKER
56-0104 SLOT BLADE
#3 (WITH GAUGE)
56-0105 SLOT BLADE**



**56-0106
SWISS MODEL
SPHERICAL TIP**



**56-0107
BARD-PARKER
SLOT BLADE #3**



**56-0108
BARRON HANDLE
SLOT BLADE #3**



**56-0109
CASTROVIEJO BLADE
BREAKER & HOLDER**



**56-0110
CHUCK HANDLE
ROUND SERRATED, 10 CM**

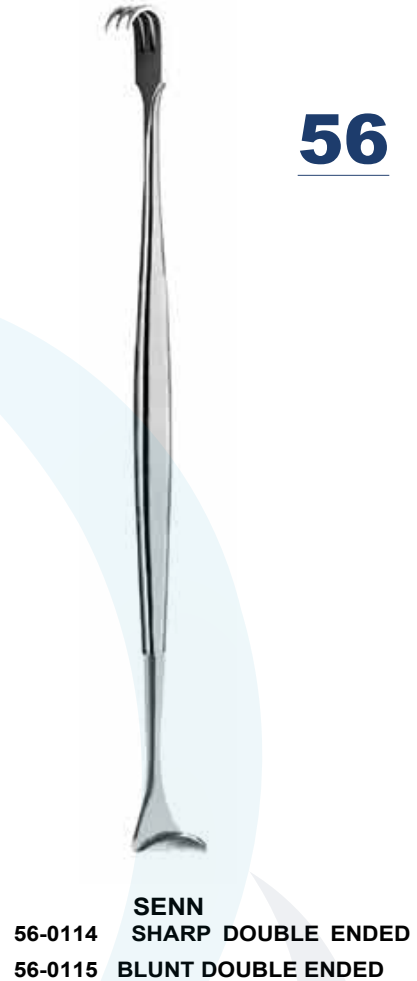
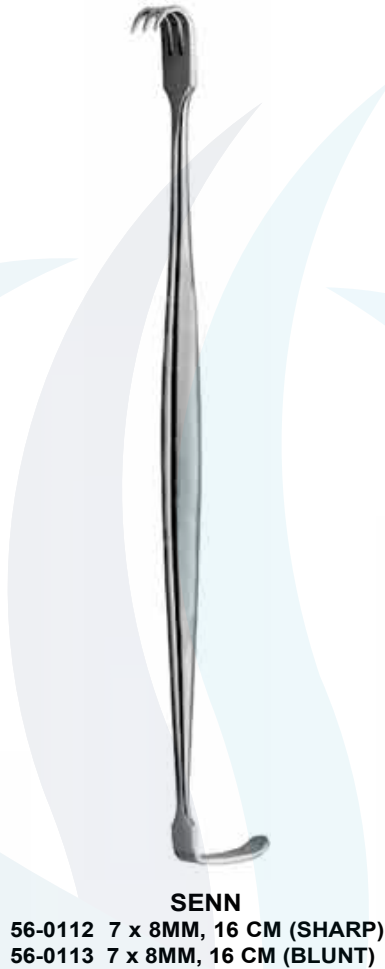

56

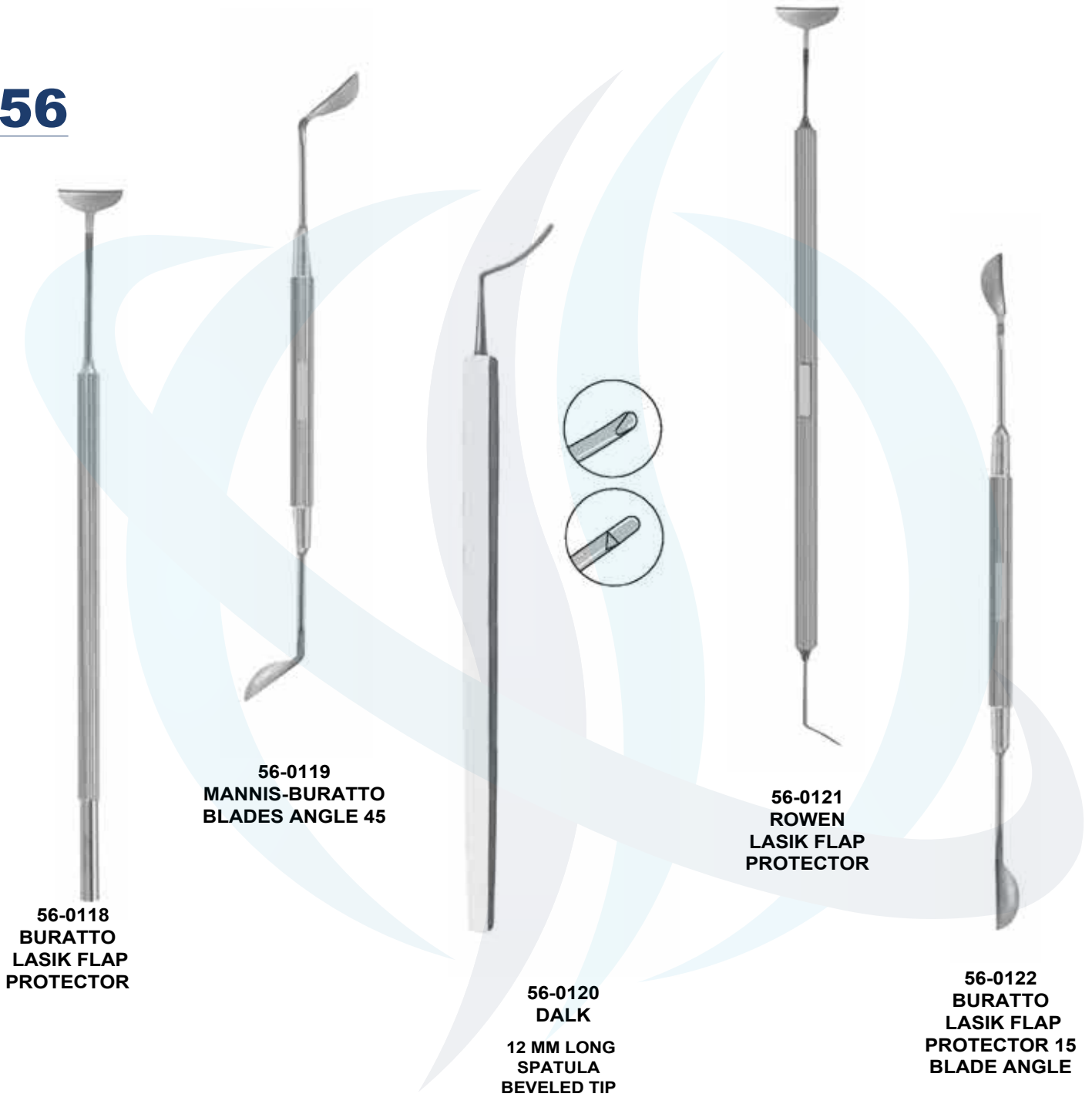

56-0118
BURATTO
LASIK FLAP
PROTECTOR

56-0119
MANNIS-BURATTO
BLADES ANGLE 45

56-0120
DALK
12 MM LONG
SPATULA
BEVELED TIP

56-0121
ROWEN
LASIK FLAP
PROTECTOR

56-0122
BURATTO
LASIK FLAP
PROTECTOR 15
BLADE ANGLE

56

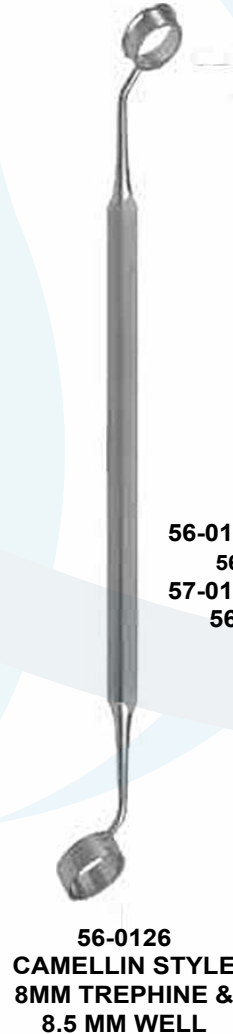
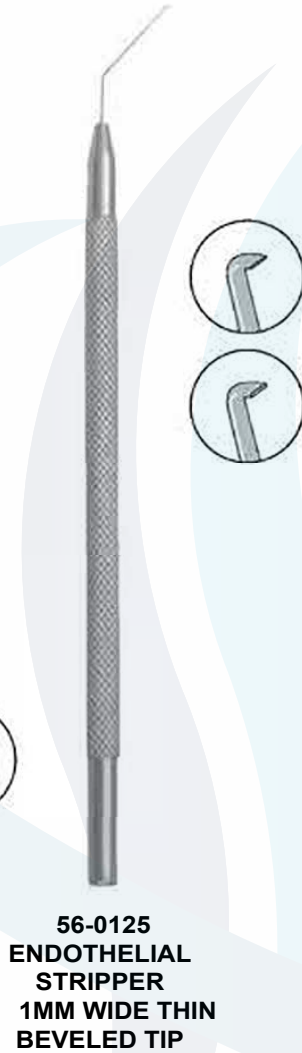
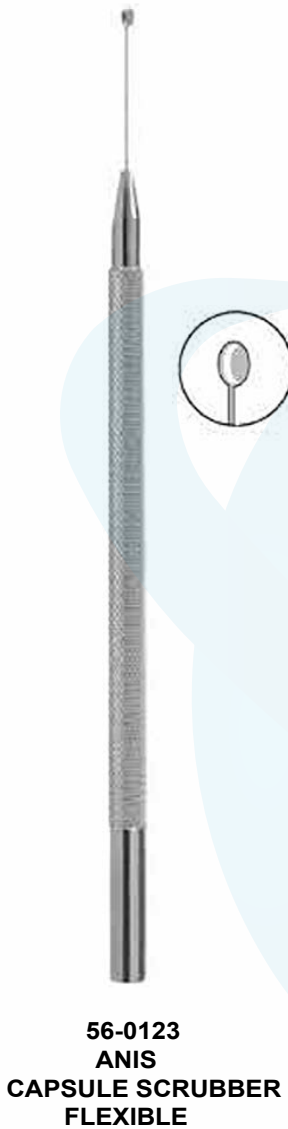

56



**56-0131
FOGLA TRIFACET
SPATULA**



**56-0132
FOGLA POINTED
DISSECTOR**



**56-0133
MORAN
LASIK ENHANCEMENT**



**CORNEAL DISSECTOR
56-0134
ANGLLED & STRAIGHT BLADE
56-0135
ANGLLED & CURVED BLADE**



**56-0136
CARLSON DSEK
SMOOTHER**

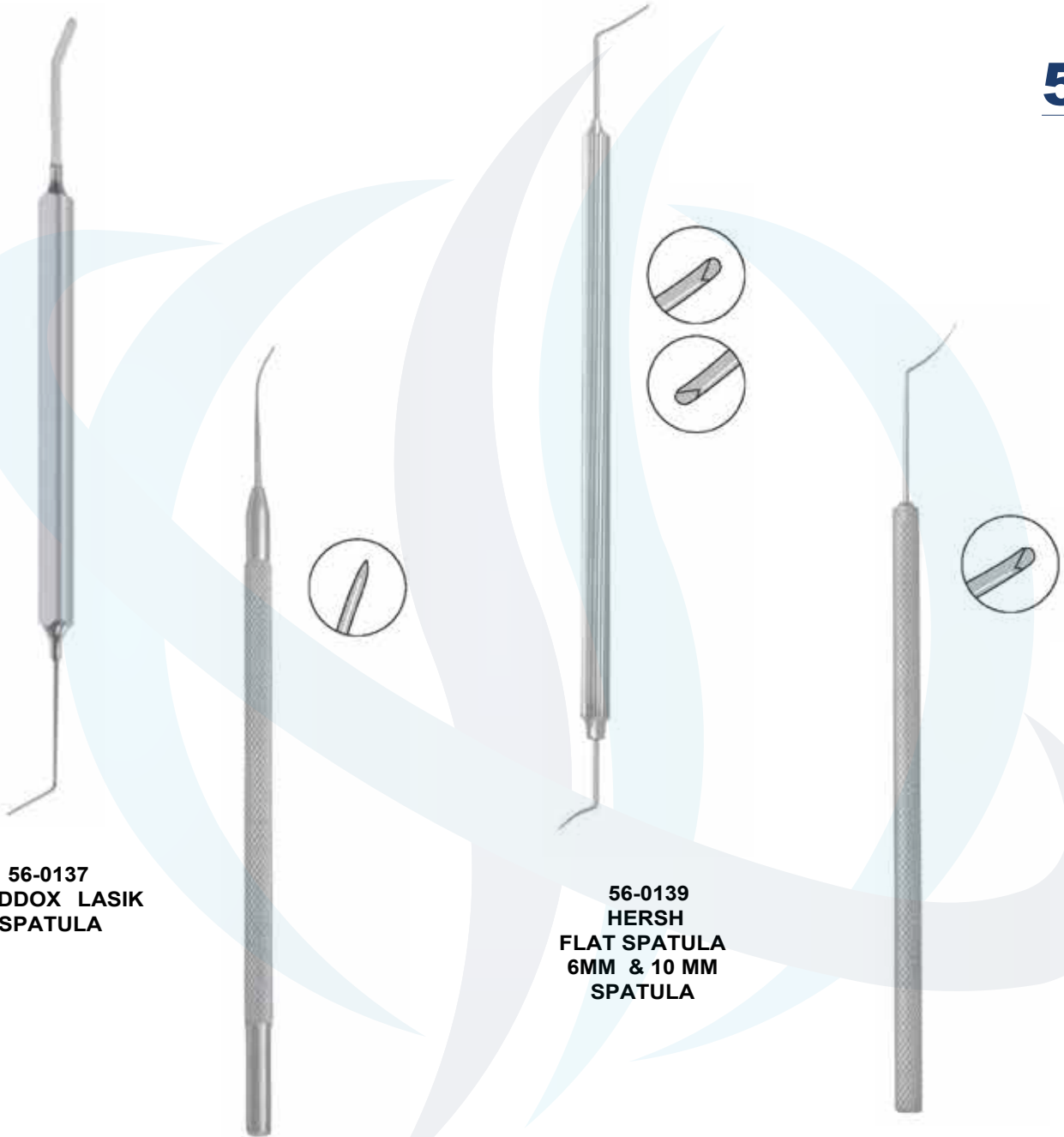

**56-0137
MADDOX LASIK
SPATULA**

**56-0138
GUIMARAES
LASIK SPATULA**

**56-0139
HERSH
FLAT SPATULA
6MM & 10 MM
SPATULA**

**56-0140
FUKASAKU
LASIK SPATULA**

56

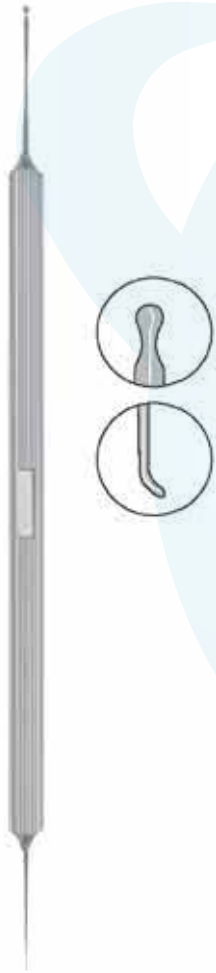

**56-0141
KATZEN
LASIK FLAP**



**56-0142
BINDER
FLAP ELEVATOR
12 MM SEMI SHARP EDGES
1 MM WIDE**



**56-0143
LESTER
IOL MANIPULATOR
0.25MM DIAMETER TIP
VAULTED SHANK**



**56-0144
JAFFE
LENS SPATULA
0.5MM WIDE**



**56-0145
LESTER
IOL MANIPULATOR
0.25MM DIAMETER TIP
STRAIGHT WITH GUARD**



56-0146
HIRSCHMAN
LENS SPATULA FLAT



56-0147
LASIK FLAP LIFTER
45° ANGLED HOOK

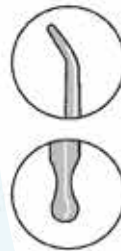

56-0148
THORLAKSON
SINSKEY HOOK &
BI-CONVEX



56-0149
BRIERLEY

56



56-0150
ESCAF
1.25MM LONG TIP



56-0151
MILDER

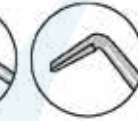

DODICK- KAMMANN
56-0152 1.5 MM LONG TIP ,STR
56-0153 1.5 MM LONG TIP ,ANG
56-0154 2.0 MM LONG TIP,STR
56-0155 2.0 MM LONG TIP ,ANG



56-0156
GIMBEL
NUCLEUS SPATULA

56

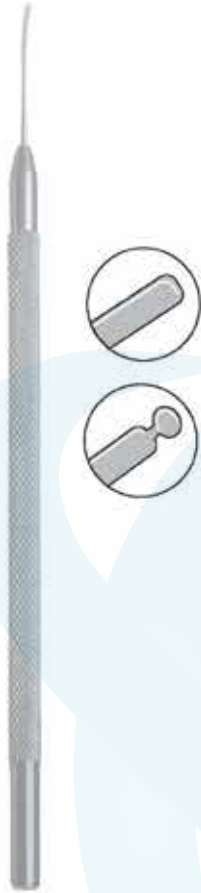

**56-0157
KOCH
DUCKBILL
SHAPED TIP**



**56-0158
KNOLLE
NUCLEUS SPATULA**



**56-0159
NEUHANN
SPATULA
BLADES**



**56-0160
NUCLEUS
SUSTAINER
BLUNT TIP**



**SCORING REVERSE
HOOK
56-0161 DSEK ANGLE
56-0162 "T" SHAPED
TIP**

**56-0163
TENNANT
BALL TIP
0.6MM**



**56-0164
HUNKELER
HEMI BALL TIP
0.3MM**



**56-0165
HUNKELER
HEMI BALL TIP
0.65MM**

56



56-0166
LIPPMAN 0.5MM
ROUND SHAFT



56-0167
GIRARD 0.5MM
WIDE SEMI
SHARP TIP



56-0168
OBSTBAUM
0.25MM WIDE
SEMI SHARP
TIP



56-0169
BENEDETTO
10MM LONG
SPATULA
BLADE



56-0170
ELSCHING
CYCLODIALYSIS
SPATULA
1.0 MM WIDE



RING MANIPULATOR
 56-0171 STRAIGHT RING
 56-0172 ANGLED RING
 56-0173 ROUNDED TIP



**56-0174
 KIMURA
 PLATINUM
 SPATULA**



**56-0175
 CASTROVIEJO
 SYNECHIAE
 SPATULA
 0.5 MM WIDE
 SEMI SHARP TIPS**



**NUCLEUS DIVIDING AND
 SEPARATING**
 56-0176 0.6 X 1.2 MM TIP
 56-0177 0.4 X 0.65 MM TIP
 56-0178 0.4 X 0.65 MM TIP



**56-0179
 CASTROVIEJO
 CYCLOCLIALYSIS
 SPATULA
 0.25 MM WIDE**

56



**56-0180
MORRISON LENS
LOOP AND PROBE**



**56-0181
KIRBY
LENS LOOP AND
MUSCLE HOOK**



**56-0182
KEENER LENS
DIVIDER**



**56-0183
LENS LOOP KANSAS
LIGHT CURVE
56-0184
KEENER - ARIT
STRONG CURVE**

56



**BUNGE
EVISCERATION SPOON
56-0185 SMALL
56-0186 LARGE**



**56-0187
PATON
SPATULA & SPOON**



**ALFONSO CUTTING
PLATFORM
56-0188 2MM WIDE
56-0189 3MM WIDE**



**GIANNETTI
56-0190
CAPTURE
SPOON**



**CULLER
56-0191
LENS
SPOON**

56



**BONN
56-0192
MICRO IRIS**



**KEUCH
56-0193
PUPIL
DILATOR**



**WELLS
56-0194
ENUCLEATION
SPOON**



**GRAETHER COLLAR
BUTTON
56-0195 STRAIGHT
56-0196 ANGLED**



**56-0197
IOL
MANIPULATOR**

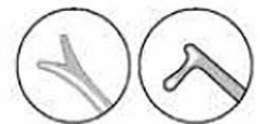

56

**KUGLEN IRIS &
 HOOK LENS
 MANIPULATOR**



**LENS
 MANIPULATOR**



PUSH-PULL
 56-0198 STRAIGHT
 56-0199 ANGLED
 56-0200 CLOVER LEAF

PUSH-PULL
 56-0201 STRAIGHT
 56-0202 ANGLED

**56-0203 BOAT HOOK
 56-0204 Y HOOK**

**56-0205
 LENS MANIPULATING
 0.15MM DIAMETER**

**DELTZ
 56-0206 0.15MM TIP
 ALIO-KELMAN
 56-0207 HOOK 0.2MM**

56



56-0208
 FIXATION HOOK
 DOUBLE SHARP



56-0209
 TWIST HOOK
 SCLERAL
 FIXATION



SILVERMAN
 56-0210
 3MM
 SPACED

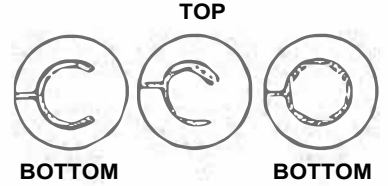

56-0211
 GLOBAL RING



56-0212
 LU-MENDEZ 11MM I.D

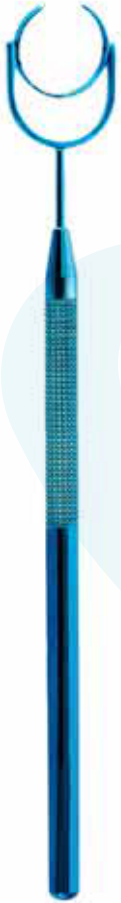

**56-0213
FINE-THORNTON
13 MM DIAMETER**



**56-0214
GIMBEL 13 MM
DIAMETER**



**56-0215
FINE-THORNTON
16 MM DIAMETER**



**HOFMANN
56-0216 11MM DIAMETER
RING**



**THORNTON
56-0217 16MM DIAMETER
S.S
57-0218 16MM DIAMETER
TITANIUM**

56



HELVESTON
56-0219
TEASER HOOK



STEVENS
56-0220
TENOTOMY
HOOK



GASS
56-0221 HOOK WITH
OVAL
HOLE



GRAEFE
MUSCLE HOOK
56-0222 SMALL
56-0223 MEDIUM
56-0224 LARGE



**HELVESTON
56-0225 LARGE**



**HELVESTON
56-0226 LARGE**



**HELVESTON
MUSCLE
HOOK
56-0227 8 MM
56-0228 10 MM
56-0229 12 MM**



**JAMESON
MUSCLE
HOOK
56-0230 SMALL
56-0231 LARGE**



**DU PLESSIS
56-0232
DOUBLE
ARM**



56



56-0233
MOORFIELDS
STRABISMUS HOOK



56-0234
GUYTON
SMALL INCISION



56-0235
GREEN
MUSCLE HOOK

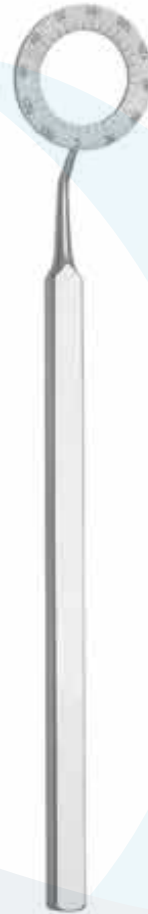

56-0236
MENDEZ
I.D 12MM



56-0237
BORES
AXIS MARKER



**56-0238
 HENDERSON
 MARKING
 SURFACE DISC
 SHAPE**

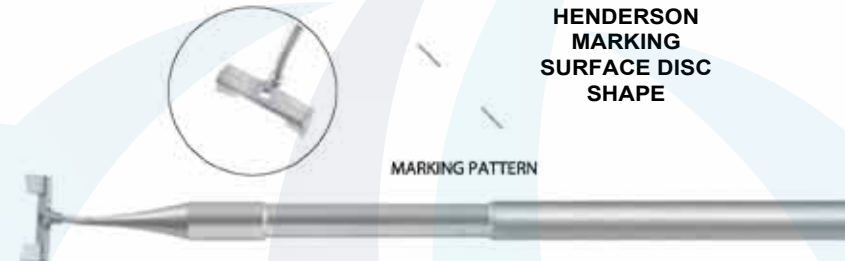

**HENDERSON
 56-0239
 IOL MARKER**

BORES

**HOFFERCROSS
 HAIR**



- | | |
|---------|---------|
| 56-0240 | 3.00 MM |
| 56-0241 | 3.25 MM |
| 56-0242 | 3.50 MM |
| 56-0243 | 4.00 MM |
| 56-0244 | 4.25 MM |
| 56-0245 | 4.50 MM |
| 56-0246 | 4.75 MM |
| 56-0247 | 5.00 MM |
| 56-0248 | 6.00 MM |
| 56-0249 | 7.00 MM |
| 56-0250 | 8.00 MM |
| 56-0251 | 9.00 MM |

**OPTIC ZONE
 MARKERS**

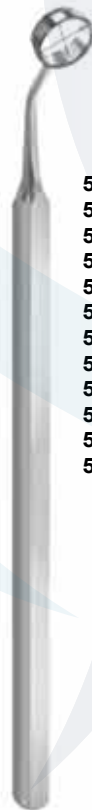

- | | |
|---------|---------|
| 56-0252 | 3.00 MM |
| 56-0253 | 3.25 MM |
| 56-0254 | 3.50 MM |
| 56-0255 | 4.00 MM |
| 56-0256 | 4.25 MM |
| 56-0257 | 4.50 MM |
| 56-0258 | 4.75 MM |
| 56-0259 | 5.00 MM |
| 56-0260 | 6.00 MM |
| 56-0261 | 7.00 MM |
| 56-0262 | 8.00 MM |
| 56-0263 | 9.00 MM |

**OPTIC ZONE
 MARKERS**



- ANIS
 4 MM DIAMETER**
- | | |
|---------|-----------|
| 56-0264 | 8 BLADES |
| 56-0265 | 12 BLADES |
| 56-0266 | 16 BLADES |



- ANIS
 8 MM DIAMETER
 56-0267
 8 RADIAL
 BLADES**

56



FECHTNER
56-0268
TRABECULECTOMY
MARKER



OSHER NEUMANN
56-0270 4 LINES
56-0271 8 LINES
56-0272 12 LINE



56-0269
MCDONALD
6.5mm & 7.0mm
DIAMETER



56-0273
PRK SCRAPER
6.5MM MARKER
LENGTH 112 MM



DOUBLE ENDED
MARKER
56-0274
5.5 MM X 5 MM
DIAMETER

56

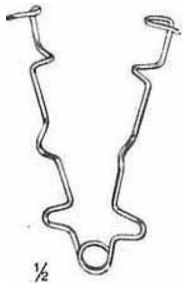

56-0275
BOWMAN Eye Spetulas

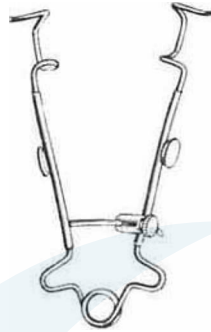

56-0276
GRAEFE

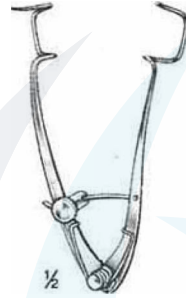

56-0277
WEISS



56-0278
BARRAQUER
 0.80 MM WIRE
 10MM BLADES



56-0279
BARRAQUER
 1 MM WIRE
 15MM BLADES

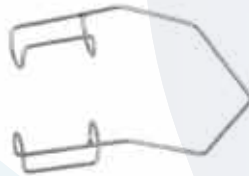

56-0280
BARRAQUER
 0.8 MM WIRE
 10MM BLADES

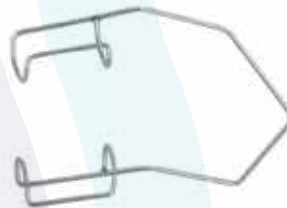

56-0281
BARRAQUER
 1 MM WIRE
 15MM BLADES

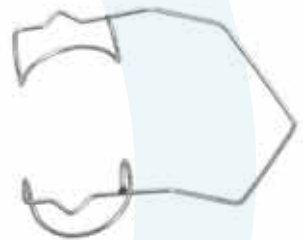

56-0282
GRANDON BARRAQUER
 1 MM WIRE
 15MM BLADES



56-0283
TEMPORAL APPROACH
 15 MM CLOSED BLADES



56-0284
TEMPORAL APPROACH
 15 MM OPEN BLADES



56-0285
KRATZ-BARRAQUER
 0.8 MM WIRE
 15 MM BLADES



56-0286
KRATZ-BARRAQUER
 1 MM WIRE
 15 MM BLADES

EYE SPECULA

Blepharostats

Blefarostatos

Lidsperrerr

56



BARRAQUER SOLID BLADES

56-0287 10 MM BLADES

56-0288 15 MM BLADES



FEASTER SOLID BLADES

56-0289 20 MM BLADES

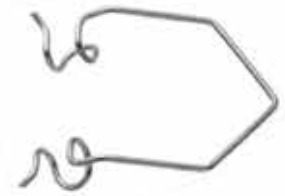

INFANT WIRE SPECULUM

56-0290 5 MM BLADES (OPEN)



56-0291

INFANT SPECULUM
5 MM BLADES (CLOSE)



56-0292

INFANT SPECULUM
6 MM BLADES (SOLID)

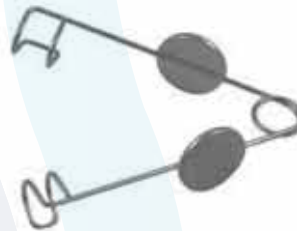

56-0293

ALPHONSO SPECULUM
5 MM BLADE & 7MM BLADE



56-0294

INFANT LID SPECULUM
4 MM BLADES



56-0295

SAUER (INFANT)
11 MM BLADES



56-0296

SAUER (PREMATURE)
2 MM BLADES



56-0297

FRANKEL
10 MM BLADES



56-0298
COOK EYE
SPECULUM 8 MM
BLADES



56-0299
COOK EYE SPECULUM
11 MM BLADES



56-0300
COOK EYE SPECULUM
15 MM BLADES

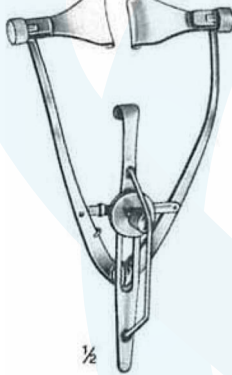

56-0301
PARK-GUYTON

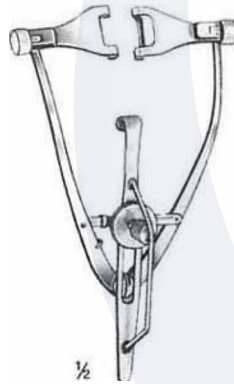

56-0302
PARK- MAUMENEE

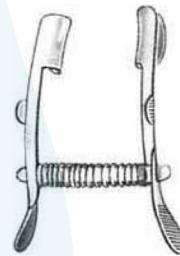

56-0303
MELLINGER BEARD



56-0304
CASTROVIEJO



56-0305
WEISS

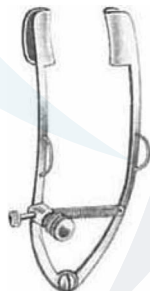

56-0306
WEISS



56-0307 7 cm
56-0308 9 cm
WILLIAMS



56-0309
SAVER

EYE SPECULA

Blepharostats

Blefarostatos

Lidsperrer



SCHULTZ MEDICAL™

56



**56-0310
KNAPP
13 MM BLADES**



**56-0311
LANCASTER
16 MM BLADES**

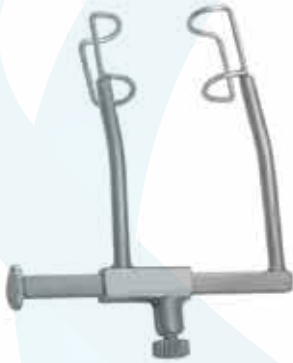

**MURDOCH
56-0312 12 MM BLADES
56-0313 15MM BLADES**



**56-0314
LESTER - BURCH
SPECULUM**

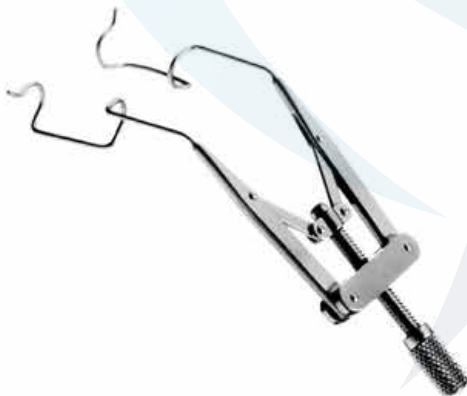

**LIEBERMAN
56-0315 5 MM BLADES
56-0316 10MM BLADES
56-0317 15MM BLADES**



**LIEBERMAN
56-0318 5 MM BLADES
56-0319 10MM BLADES
56-0320 15MM BLADES**



JAFFE
 56-0321 13 MM BLADES
 56-0322 15MM BLADES



STEVENSON
 56-0323
 13 MM BLADES



STEVENSON
 56-0324
 13 MM BLADES
 SOLID

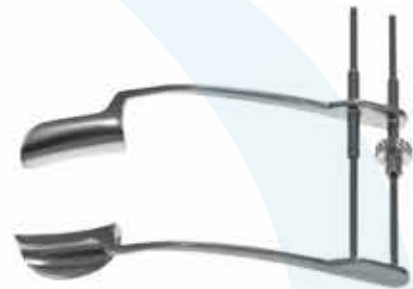

BANGERTER
 56-0325 10 MM BLADES
 56-0326 15 MM BLADES



CASTROVIEJO
 56-0327 5 MM BLADES
 56-0328 10 MM BLADES
 56-0329 14 MM BLADES
 56-0330 16 MM BLADES

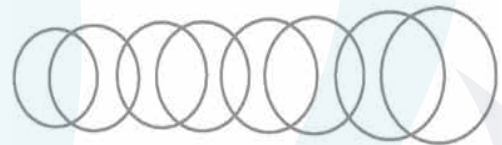

FLIERINGA
 56-0331 15 MM
 22MM RING



MCNEIL - GOLDMAN
 56-0332 15 MM
 56-0333 16 MM
 56-0334 17 MM



HELVESTON
 56-0335 7MM BLADE
 56-0336 9MM BLADE
 56-0337 11MM BLADE

56



**56-0338
KELLY
1.0 MM DIAMETER
0.75 MM DEEP BITE**



**56-0339
GASS
1.5 MM DIAMETER
0.75MM DEEP BITE
ROTATABLE TIP**



**56-0340
CHRISTENSEN
1MM WIDE BITE**



FRAZIER
56-0341 12 CM LONG
56-0342 17 CM LONG



SCHAEDEL
56-0343
TOWEL
CLAMP



BABY JONES
56-0344 55 MM
LONG



DIEFFENBACH
SERREFINE, 50 MM
56-0345 STRAIGHT
56-0346 CURVED



SERREFINE
SERRATED JAWS
56-0347
SMALL 38 MM

56-0348
PEAN FORCEPS
MOSQUITO FORCEPS
STRAIGHT
SERRATED JAWS

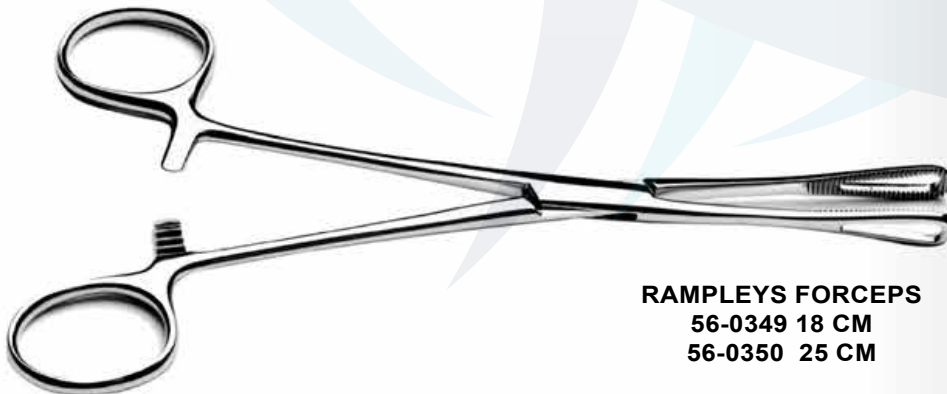
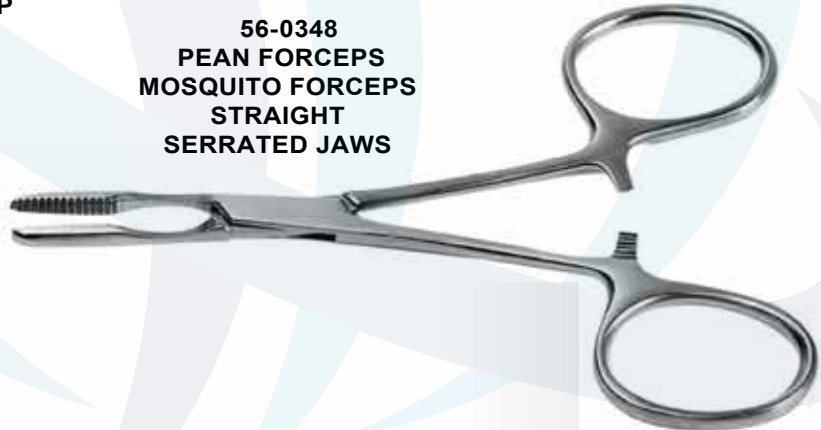

RAMPLEYS FORCEPS
56-0349 18 CM
56-0350 25 CM

56



**HALSTED
5 " MOSQUITO
DELICATE FORCEPS
56-0351 STRAIGHT
56-0352 CURVED**



**HALSTED
5 " MOSQUITO
FORCEPS DELICATE
1X2 TEETH
56-0353 STRAIGHT
56-0354 CURVED**

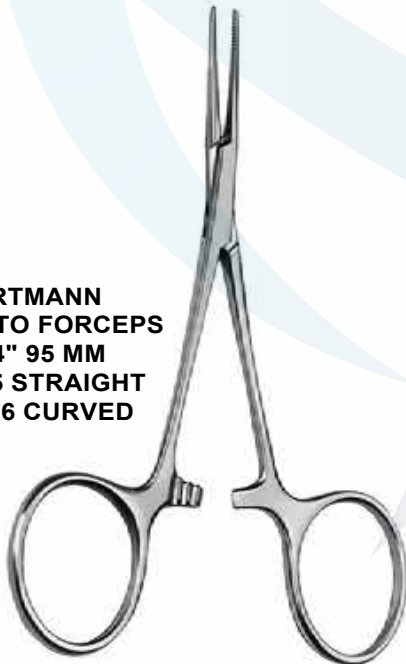

**HARTMANN
MOSQUITO FORCEPS
3 3/4" 95 MM
56-0355 STRAIGHT
56-0356 CURVED**



**BACKHAUS
TOWEL CLAMP
56-0357 90 MM S.S
56-0358 135 MM S.S
56-0359 90 MM TITANIUM
56-0360 135MM TITANIUM**



MOSQUITO FORCEPS
56-0361 STRAIGHT 9 CM
56-0362 CURVED 9 CM
56-0363 STRAIGHT 12.5 CM
56-0364 CURVED 12.5 CM



MAYO NEEDLE
56-0365 13 CM
56-0366 16 CM
56-0367 18CM



KELLY FORCEPS
56-0368 14 CM
56-0369 18 CM



SPONGE SCISSOR
56-0370 18 CM
56-0371 25 CM

NEEDLE HOLDERS

Porte-aiguilles

Portaagujas

Nedelhalter



SCHULTZ MEDICAL™

56

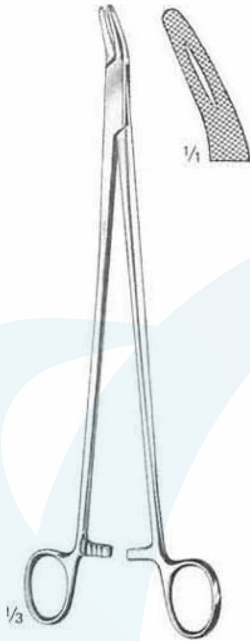

FINOCCHIETTO
56-0372
27.0cm



MASSON
56-0373
27.0cm



WANGENSTEEN
56-0374
27.0cm



OLSEN HEGAR

56-0375
14cm



56-0376
16 cm



OLSEN HEGAR
56-0377 18 cm



GILLIES
56-0378 14 cm
56-0379 17 cm

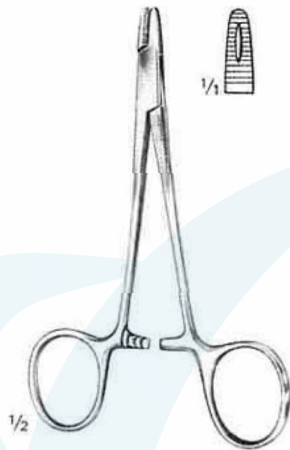

**56-0380
DERF**
12.0cm

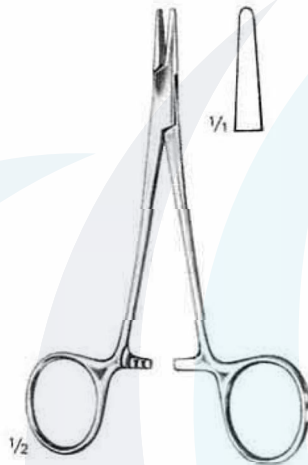

**56-0381
WEBSTER**
13.0cm

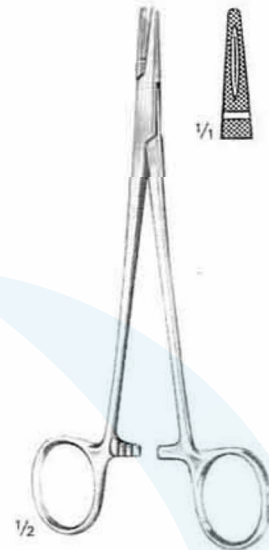

CRILE-WOOD
56-0382 15cm
56-0383 18cm
56-0384 20cm



CRILE-MURRAY
56-0385 15 cm



MAYO-HEGAR
56-0386 13cm

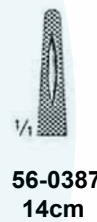

56-0387
14cm



56-0388
16cm



56-0389
18cm



56-0390
20cm



56-0391
24cm



56-0392
26cm

NEEDLE HOLDERS

Porte-aiguilles

Purtaagujas

Nedelhalter

56



**56-0393
JAFFE
NEEDLE HOLDER
WITH LOCK
CURVED**



**56-0394
JAFFE
NEEDLE HOLDER
WITHOUT LOCK
CURVED**



**MCPHERSON
56-0395 WITH LOCK STRAIGHT
56-0396 WITHOUT LOCK STRAIGHT
56-0397 WITH LOCK CURVED
57-0398 WITHOUT LOCK CURVED**



**56-0399 SILCOCK NEEDLE
HOLDER , CATCH**



DRAWS

- 56-0400 WITH LOCK STRAIGHT
- 56-0401 WITH LOCK STRAIGHT
- 56-0402 WITHOUT LOCK STRAIGHT
- 56-0403 WITH LOCK CURVED
- 57-0404 WITHOUT LOCK CURVED



CASTROVIEJO

- DELICATE JAWS TITANIUM
- 56-0405 WITH LOCK STRAIGHT
- 56-0406 WITHOUT LOCK STRAIGHT
- 56-0407 WITH LOCK CURVED
- 57-0408 WITHOUT LOCK CURVED



**BARRAQUER
 STRAIGHT**

- 56-0409 WITH LOCK
- 56-0410 WITHOUT LOCK



**TROUTMAN DELICATE
 JAWS**

- 56-411 WITHOUT LOCK
- 56-412 WITH LOCK

NEEDLE HOLDERS

Porte-aiguilles
Purtaaguja
Nedelhalter

56



BARRAQUER CURVED
56-0413 WITH LOCK
56-0414 WITHOUT LOCK



BARRAQUER CURVED
56-0415 WITH LOCK STAINLESS STEEL
56-0416 WITHOUT LOCK STAINLESS STEEL
56-0417 WITH LOCK TUNGSTEN CARBIDE
56-0418 WITHOUT LOCK TUNGSTEN CARBIDE
56-0419 WITH LOCK TITANIUM
56-0420 WITHOUT LOCK TITANIUM



BARRAQUER CURVED
56-0421 WITH LOCK STRAIGHT
56-0422 WITHOUT LOCK STRAIGHT
56-0423 WITH LOCK CURVED
57-0424 WITHOUT LOCK CURVED



**BARRAQUER GOLF
 PATTERN, CURVED**
 56-0425 WITH LOCK
 56-0426 WITHOUT
 LOCK



**BARRAQUER NEEDLE HOLDER,
 CURVED, 115MM**
 56-0427 WITH LOCK
 56-0428 WITHOUT
 LOCK



**MICRO NEEDLE
 HOLDER, STRAIGHT**
 56-0429 WITH LOCK
 56-0430 WITHOUT
 LOCK



**NEEDLE HOLDER,
 CURVED, 115MM**
 56-0431 WITH LOCK S.S
 56-0432 WITHOUT LOCK S.S
 56-0433 WITH LOCK TITANIUM
 56-0434 WITHOUT LOCK TITANIUM



**BARRAQUER
 STRAIGHT**
 56-0435 WITH LOCK S.S
 56-0436 WITHOUT LOCK S.S
 56-0437 WITH LOCK TITANIUM
 56-0438 WITHOUT LOCK
 TITANIUM

56

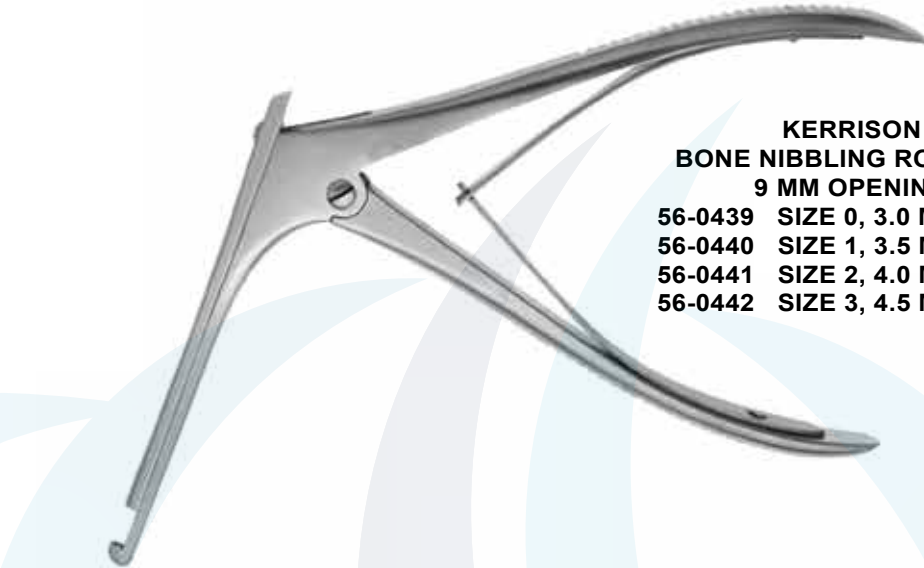

**KERRISON
BONE NIBBLING RONGEUR
9 MM OPENING**
56-0439 SIZE 0, 3.0 MM WIDE
56-0440 SIZE 1, 3.5 MM WIDE
56-0441 SIZE 2, 4.0 MM WIDE
56-0442 SIZE 3, 4.5 MM WIDE

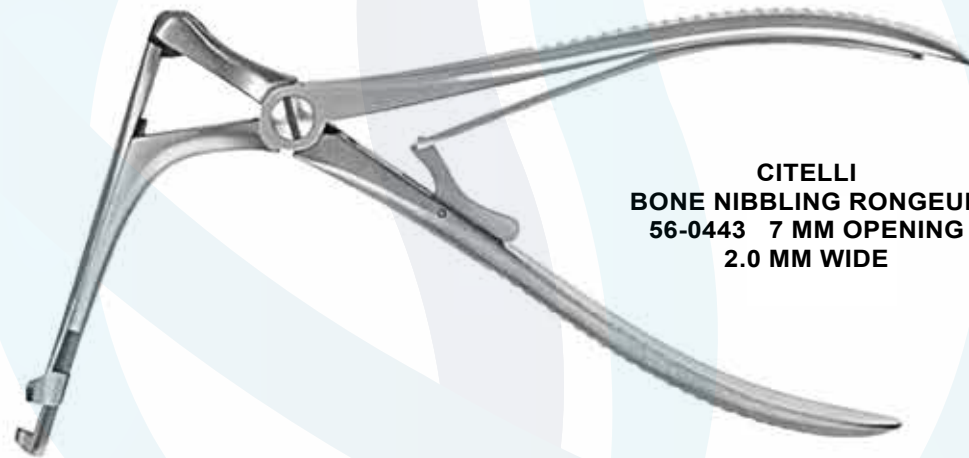

**CITELLI
BONE NIBBLING RONGEUR
56-0443 7 MM OPENING
2.0 MM WIDE**



**BEYER RONGEUR
56-0444
SINGLE ACTION**



FREER
 56-0445 4.5 MM
 WIDE BLADES



JOSEPH
 56-0446 CURVED
 TIP



WEST
 56-0447 STRAIGHT
 LACRIMAL CHISEL



FREER
 56-0448 CURVED
 LACRIMAL CHISEL



NASAL
 INFANT CHILD ADULT
 56-0449 56-0450 56-0451

56



MALLET
56-0452
STAINLESS
STEEL HEAD



INFANT
56-0453 VERY
FINE BLUNT TIP



MULDOON
56-0454
LACRIMAL
DILATOR



WILDER
56-0455 SIZE 1, FINE TAPER
56-0456 SIZE 2, MEDIUM TAPER
56-0457 SIZE 3, HEAVY TAPER

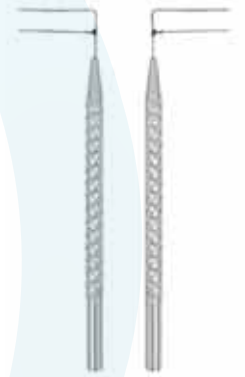

HARMS
56-0458
TRABECULOTOMY
PROBE

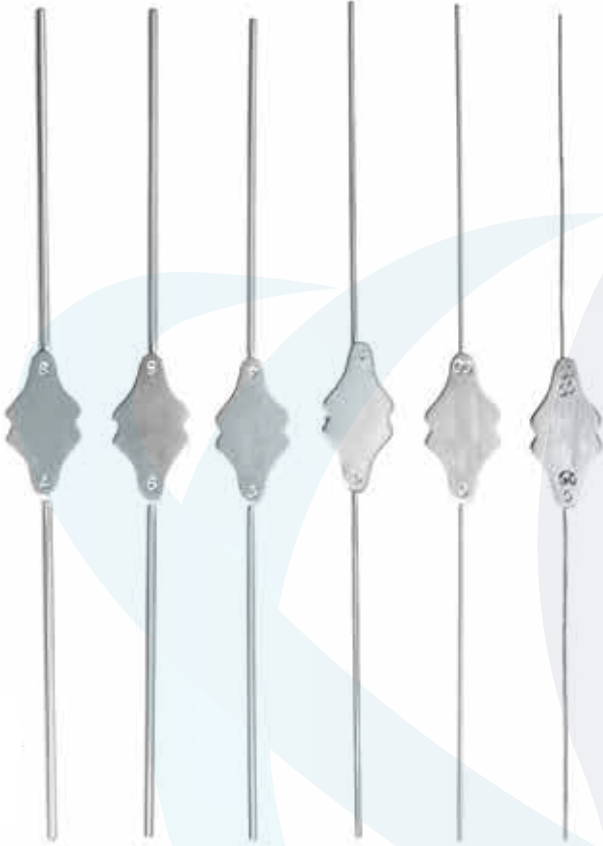

6 C K A 5 B
 G 9 H C : * *
 56-0 (59 G = N 9 \$\$\$\$ / \$\$\$
 56-0 (* 0 G = N 9 \$ \$ / \$
) (10 * 1 G = N 9 % / &
) (10 * 2 G = N 9 ' / (
) (10 * 3 G = N 9 ') / *
) * 10 (* 4 G = N 9 ' + / ; ,

7 5 G H F C J = 9 > C '
) * 10 (6 5 ' 8 C I 6 @
 9 B 8 ' A 9 8 = A
 H 5 D 9 F

7 5 H 5 @ B C
) * 10 (6 6 \$ ' + ' A A
 8 = 5 A 9 H 9 F ' \$ ') ' 7 A



7 F 5 K : C F 8
) * 10 (6 7 ' \$ * ' A A
 8 = 5 A 9 H 9 F ' \$ ') ' 7 A



C D < H < 5 @ A C @ ; M 6 C K A 5 B '
 7 M @ B 8 F = 7 5 @
) * 10 (6 8

56



**56-0469
PIGTAIL PROBE**



**56-0470
ROLLET
RUGINE**



**56-0471
NETTLESHIP
LACRIMAL DILATOR
DOUBLE END**



**56-0472
NETTLESHIP
LACRIMAL DILATOR
SINGLE END**



**56-0473
HOWARTH PERIOSTIAL
ELEVATOR
215 MM LENGTH**



**56-0474
CRAWFORD**



**56-0475
FISON
RETRACTOR**

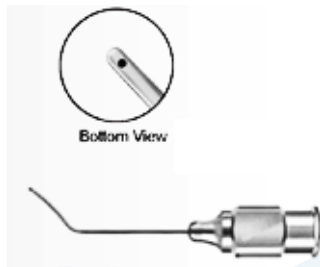

**56-0476
DALK
AIR INJECTION CANNULA
27 GAUGE**

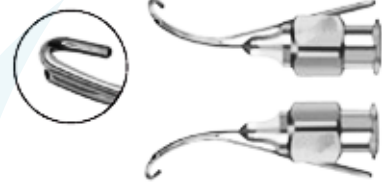

**56-0477
GESS
23 GAUGE, CURVED RIGHT AND
LEFT**

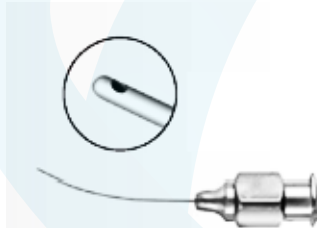

**56-0478
CORBIN
CANNULA SMOOTH
ROUNDED
23 GAUGE**

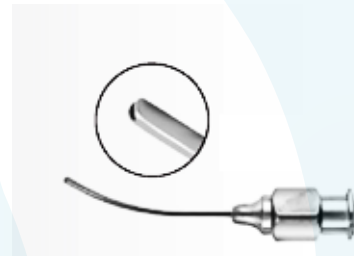

**56-0479
STEVENS
FLAT TIP 19 GAUGE**

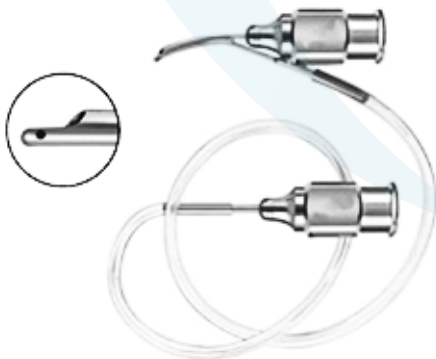

**56-0480
SIMCOE
15 MM LONG 0.3MM DIAMETER
ASPIRATION PORT**

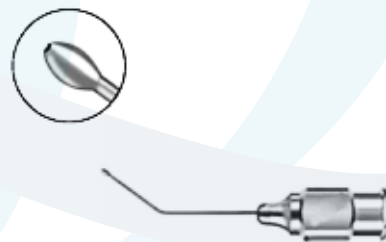

**56-0481
LASEK
OLIVE SHAPED TIP
25 GAUGE**

56

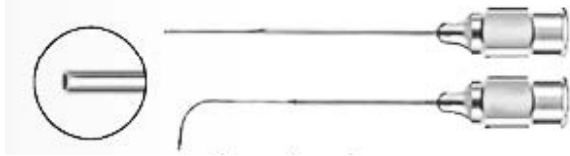

LACRIMAL
56-0482 STRAIGHT
56-0483 CURVED
23 GAUGE

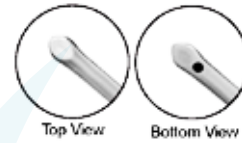

56-0484
DALK
COBRA SHAPED
27 GAUGE



AIR INJECTION
56-0485 30 GAUGE
56-0486 27 GAUGE
ANGLE AT 7MM

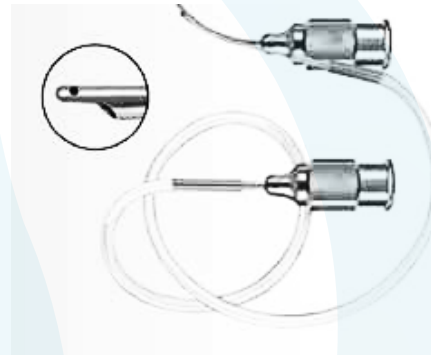

56-0487
REVERSED SIMCOE
15MM LONG
23 GAUGE



SIMCOE
56-0488 CURVED RIGHT
56-0489 CURVED LEFT
0.3MM ANTERIOR U-SHAPED
23 GAUGE

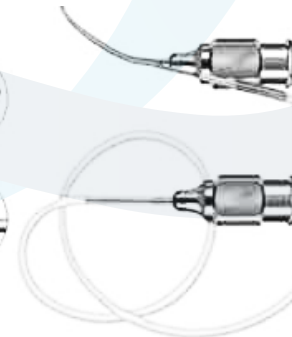
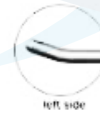

56-0490
STRAUSS-SIMCOE
15° ANGLED TIP
23 GAUGE



**56-0491
KELMAN
CYSTOTOME
SHARP POINT AND
CUTTING EDGE
22 GAUGE**



**56-0492
MCINTYRE
CYSTOTOME
ANGLED AT 10 MM
SHARP POINT
23 GAUGE**

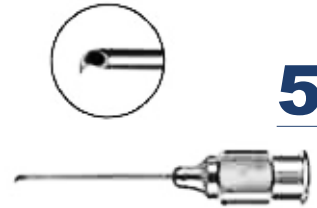

**56-0493
LIEPPMAN
CYSTOTOME
EXTRA SMALL
SHARP POINT
22 GAUGE**

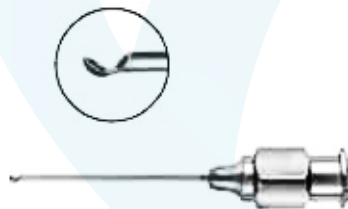

**56-0494
SHAMMAS
POSTERIOR CAPSULE
1 MM DIAMETER CUP
22 GAUGE**

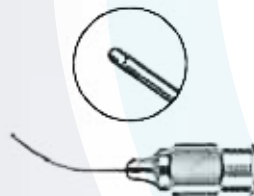

**56-0495
SHAPIRO
POSTERIOR
CAPSULE
0.3MM SIDE PORTS
CURVED , 23 GAUGE**



**56-0496
KRATZ
CYSTOTOME
SHARP POINT
SHARP CUTTING
22 GAUGE**



**JENSEN
POSTERIOR
CAPSULE
OLIVE TIP
56-0497 25 GAUGE
56-0498 23 GAUGE**

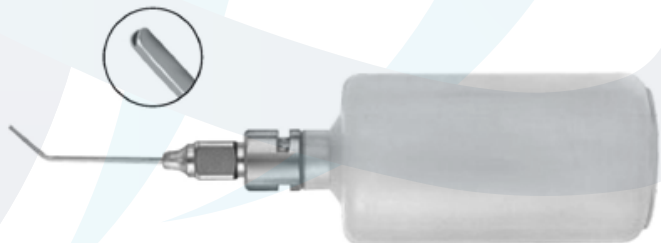

**BISHOP-HARMON
56-0499 19 GAUGE CANNULA
56-0500 21 GAUGE CANNULA**

56



56-0501
LU
POSTERIOR CAPSULE
POLISHER OLIVE
SHAPED TIP
23 GAUGE



56-0502
DAHAN
NUCLEUS PROLAPSING CANNULA
ANGLED AT 4MM
MINIATURE OLIVE TIP
0.15 MM END OPENING
25 GAUGE



56-0503
HYDRODISSECTION
CANNULA
ANGLED AT 8 MM
FLAT TIP
25 GAUGE



56-0504
IRRIGATING CANNULA
DUAL 0.4MM SIDE PORTS
23 GAUGE THIN WALL



56-0505
FUKASAKU
LASIK CANNULA
23 GAUGE



56-0506
BANAJI
LASIK CANNULA
BULLET SHAPED TIP 6 PORTS
25 GAUGE

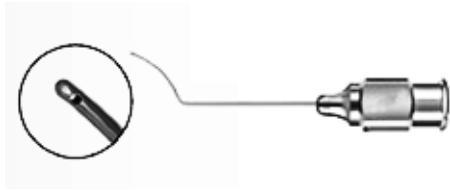

**BURATTO
LASIK CANNULA**
56-0507 25 GAUGE
56-0508 23 GAUGE

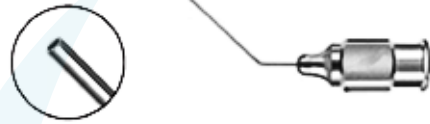

**MCINTYRE
ANTERIOR CHAMBER
CANNULA SMOOTH BLUNT**
56-0509 23 GAUGE, STRAIGHT
56-0510 23 GAUGE, ANGLED
56-0511 26 GAUGE, STRAIGHT
56-0512 26 GAUGE, ANGLED
56-0513 30 GAUGE, STRAIGHT
56-0514 30 GAUGE, ANGLED



**56-0515
GIMBEL
CORTEX ASPIRATING
CANNULA
END OPENING**

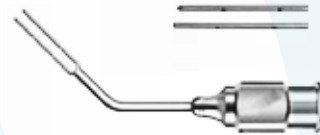

**56-0516
VIDAURRI
LASIK CANNULA
25 GAUGE**



**56-0517
SIMCOE
CORTEX EXTRACTOR
13 MM LONG
23 GAUGE**



**56-0518
SIMCOE
CORTEX EXTRACTOR
21 MM LONG
23 GAUGE**

56

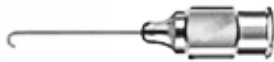

**56-0519
MCINTYRE-BINKHORST
CANNULA, J SHAPE
SMOOTH BLUNT TIP
26 GAUGE**



**56-0520
CHANG
HYDRODISSECTION CANNULA
FLAT TIP ANGLED 90°
27 GAUGE**



**56-0521
KNOLLE-PEARCE
IRRIGATING VECTIS
23 GAUGE LOOP**



56-0522 56-0523

**SIMCOE
IRRIGATING LENS NUCLEUS
LOOP
FINELY SERRATED, CURVE
25 GAUGE**

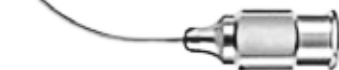

**56-0524
SIMCOE
CORTEX EXTRACTOR
0.4 MM SIDE PORT
21 MM LONG
23 GAUGE THIN WALL**



**56-0525 56-0526
2.5MM 4.0 MM
ALFONSO-MCINTYRE
IRRIGATING NUCLEUS SPOON**



MICRO
56-0527
18CM



MICRO
56-0528
18CM



56-0529



56-0530

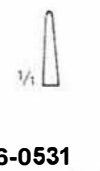

56-0531



56-0532



CASTROVIEJO
WITHOUT CATCH
14CM



CASTROVIEJO
WITH CATCH
14CM

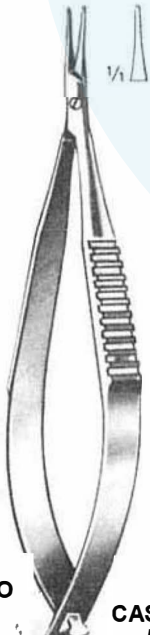

MICRO
CASTROVIEJO
56-0533
without catch

10CM

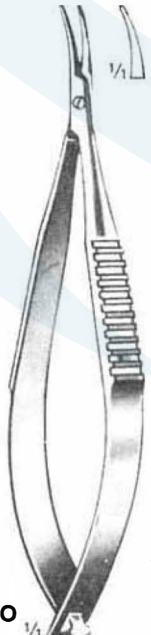

MICRO
CASTROVIEJO
56-0534
without catch

10CM



MICRO CASTROVIEJO
56-0535
with catch

10CM

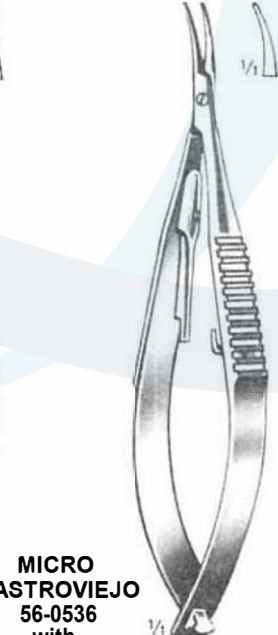

MICRO
CASTROVIEJO
56-0536
with catch

18CM

MICRO NEEDLE HOLDERS

Micro Porte-aiguilles
Micro Purtaagujas
Micro-Nedelhalter

56

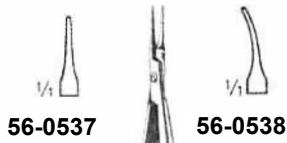

MICRO-CASTROVIEJO WITHOUT CATCH
14CM

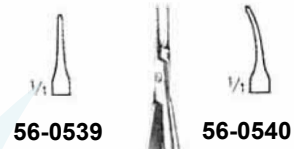

MICRO-CASTROVIEJO WITH CATCH
14CM



BARRAQUER
56-0541
WITHOUT CATCH
12CM



BARRAQUER
56-0542
WITHOUT CATCH
13CM



56-0543

56-0544



MICRO-BARRAQUER
Without catch
10CM



56-0545

56-0546

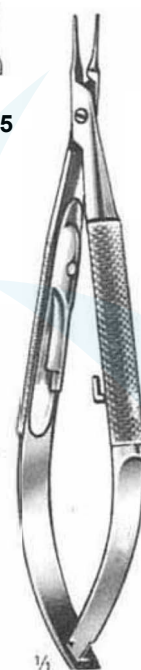

MICRO-BARRAQUER
Without catch
10CM



CASTROVIEJO
56-0547
Without Catch
13CM



CASTROVIEJO
56-0548
With Catch
13CM

MICRO NEEDLE HOLDERS

Micro Porte-aiguilles

Micro Portaaguas

Micro-Nedelhalter

56

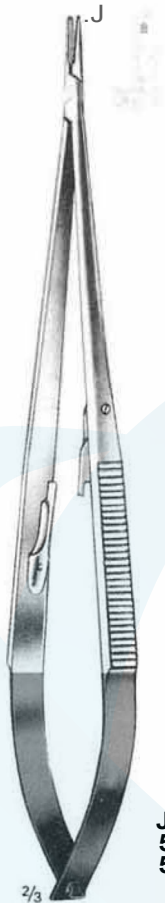

JACOBSON
56-0549 TC 18CM
56-0550 TC 20CM

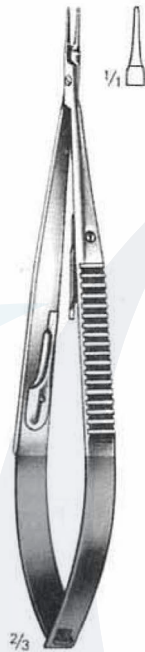

CASTROVIEJO
56-551 TC
14CM



56-0552 TC



56-0553 TC

MICRO CASTROVIEJO
14CM

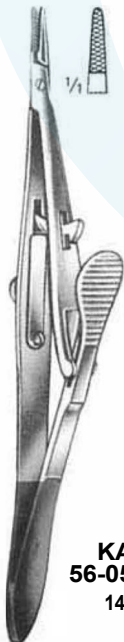

KALT
56-0554 TC
14CM



CASTROVIEJO
56-0555 TC
13CM



**NEEDLE
HOLDER TC**
56-0556
18 CM



CASTROVIEJO
56-0557



CASTROVIEJO
56-0558



CASTROVIEJO
56-0559



CASTROVIEJO
56-0563
18CM

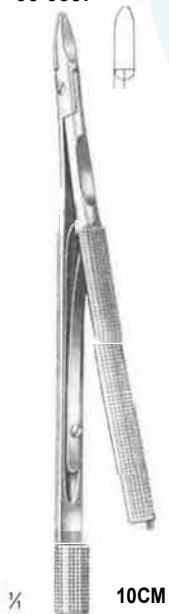

TROUTMAN-CHRIS
56-0560



TROUTMAN-CHRIS
56-0561



BARRAQUER
56-0562

56

EYE SCISSOR



- 56-0564 POINTED TIPS
- 56-0565 STANDARD STRAIGHT S.S
- 56-0566 STANDARD CURVED S.S
- 56-0567 TUNGSTEN CARBIDE STRAIGHT
- 56-0568 TUNGSTEN CARBIDE CURVED
- 56-0569 SUPER CUT STRAIGHT
- 56-0570 SUPER CUT CURVED

STEVENS SCISSOR



- 56-0571 BLUNT TIPS
- 56-0572 STANDARD STRAIGHT S.S
- 56-0573 STANDARD CURVED S.S
- 56-0574 TUNGSTEN CARBIDE STRAIGHT
- 56-0575 TUNGSTEN CARBIDE CURVED
- 56-0576 SUPER CUT STRAIGHT
- 56-0577 SUPER CUT CURVED

EYE SCISSOR



- 56-0578 STRAIGHT
- 56-0579 CURVED



- STITCH SCISSOR**
- 56-0580 NEEDLE POINT CURVED

**KNAPP SCISSOR
BLUNT TIPS**

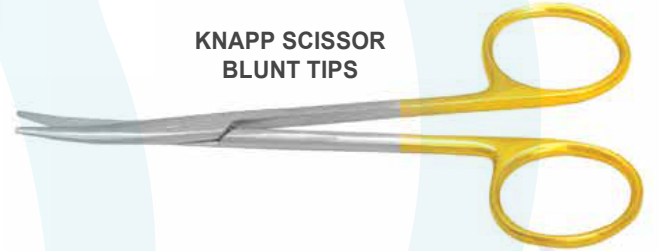

- 56-0581 BLUNT TIPS
- 56-0582 STANDARD STRAIGHT S.S
- 56-0583 STANDARD CURVED S.S
- 56-0584 TUNGSTEN CARBIDE STRAIGHT
- 56-0585 TUNGSTEN CARBIDE CURVED
- 56-0586 SUPER CUT STRAIGHT
- 56-0587 SUPER CUT CURVED

STEVENS BLUNT TIPS

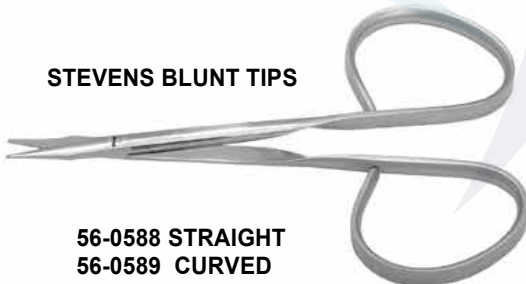

- 56-0588 STRAIGHT
- 56-0589 CURVED

**STRABISMUS SCISSOR
BLUNT TIPS**

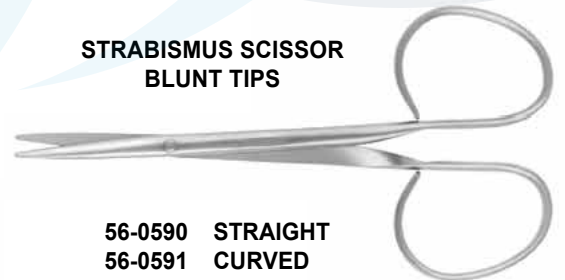

- 56-0590 STRAIGHT
- 56-0591 CURVED



ENUCLEATION SCISSORS
BLUNT TIPS
56-0592 MEDIUM CURVE
56-0593 STRONG CURVE



METZENBAUM
14.5 CM
56-0594 STAINLESS STEEL
56-0595 TUNGSTEN CARBIDE
56-0596 SUPERCUT



UTILITY SCISSORS
14.5 CM
SHARP & BLUNT
56-0597 STAINLESS STEEL
56-0598 TUNGSTEN CARBIDE
56-0599 SUPER CUT



BLACK COATED SCISSOR
56-0600 STRAIGHT
56-0601 CURVED

56



STITCH SCISSOR
56-0602
STRAIGHT 9 CM



DRESSING SCISSOR
56-0603 STRAIGHT S/S
56-0604 STRAIGHT B/B
56-0605 CURVED B/B
56-0606 CURVED S/S

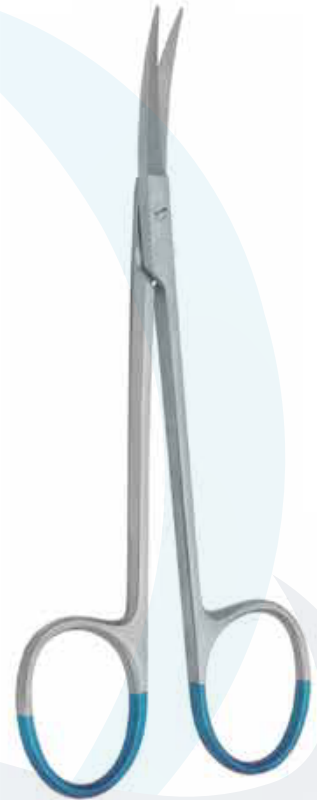

IRIS SCISSOR
56-0607 STRAIGHT 9 CM
56-0608 CURVED 9 CM
56-0609 STRAIGHT 11 CM
56-0610 CURVED 11CM



STRABISMUS
56-0611 11 cm
Straight

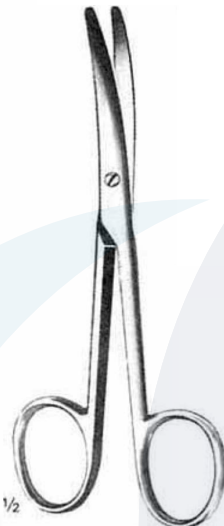

STRABISMUS
56-0612 11 cm
Curved

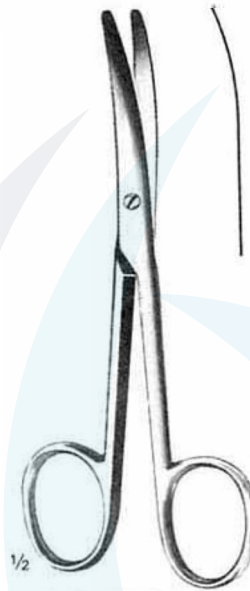

STRABISMUS
56-0613 13 cm
Heavy pattern,
light Curved

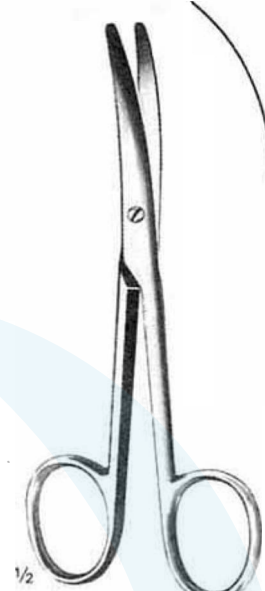

STRABISMUS
56-0614 13 cm
Heavy pattern,
Full Curved



56-0615



56-0616

WESTCOTT
11 cm



WECKER
11 cm



56-0617
SH/SH



56-0618
SH/BL



56-0619
BL/BL



NOYES
56-0620
12 cm

EYE SCISSORS, SPRING ACTION

Ciseaux oculaires a ressort
Tijeras oculares con resorte
Augenfederscheren

56

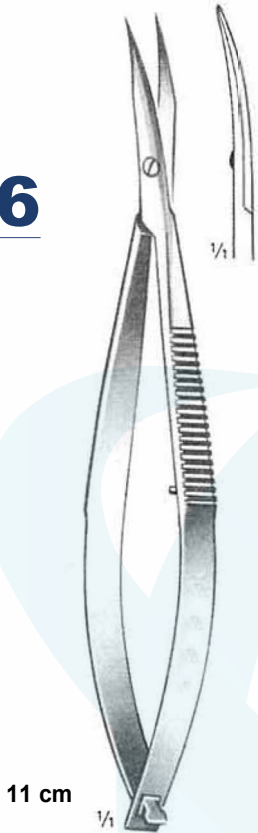

11 cm
WESTCOTT
56-0621
sharp point, curved

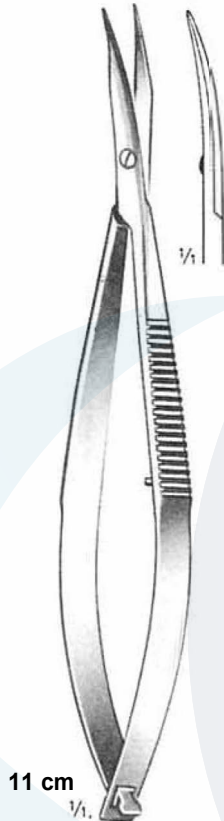

11 cm
WESTCOTT
56-0622

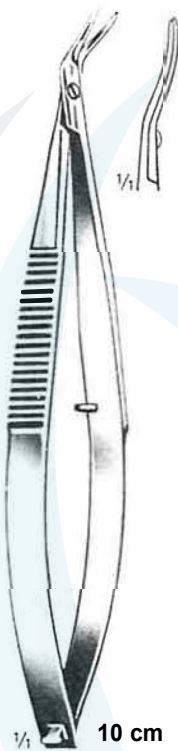

10 cm
CASTROVIEJO
56-0623
sharp point, curved

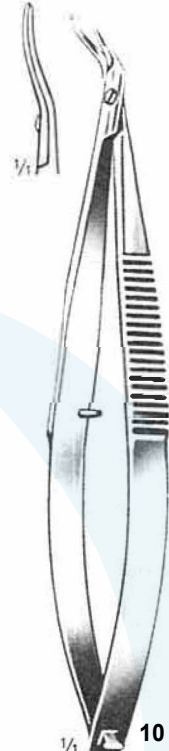

10 cm
CASTROVIEJO
56-0624
blunt point, curved

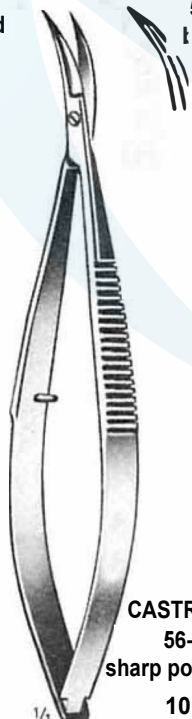

10 cm
CASTROVIEJO
56-0625
sharp point, curved



10 cm
CASTROVIEJO
56-0626
blunt point, curved



10 cm
KATZIN-BARRAQUE.
56-0627 BLUNT
56-0628 SHARP



MCPHERSON-WESTCOTT
56-0629 SMALL BLADES



TIBOLT
56-0630 PUNCTAL SCISSOR



TIBOLT
56-0631 TENOTOMY SCISSOR



MCPHERSON-WESTCOTT
56-0632
STITCH SCISSOR
SMALL BLADES CURVED



JAFFE
56-0633
STITCH SCISSOR
MEDIUM BLADES CURVED



IRIS
56-0634 SCISSOR
SMALL BLADES STRAIGHT

EYE SCISSORS, SPRING ACTION

Ciseaux oculaires a ressort
Tijeras oculares con resorte
Augenfederscheren

56



**FINE
STITCH SCISSOR**
56-0635 MEDIUM BLADES,
STRAIGHT
56-0636 MEDIUM BLADES, CURVED



**56-0637
FOGLA SCISSOR
RIGHT**



56-0639 CORNEAL SCISSOR
8 MM LONG BLADES, ANGLED



**56-0638
UTHOFF
CAPSULOTOMY SCISSORS**
7 MM LONG BLADE

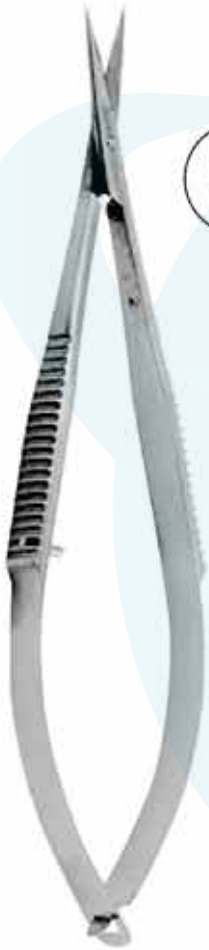

56-0640
NOYES
MULTIPURPOSE
SCISSORS STRAIGHT
BLUNT TIP



56-0641
WESTCOTT
SCISSOR BLUNT
TIPS



56-0642
CORNEAL
SCISSOR
BLUNTS TIPS



56-0643
CORNEAL
SCISSOR
BLUNTS TIPS

MICRO SCISSORS, SPRING ACTION

Microciseaux a ressort
Microtijeras con resorte
Micro-Federscheren



SCHULTZ MEDICAL™

56

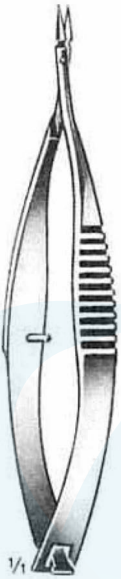

VANNAS
56-0644
straight
10CM

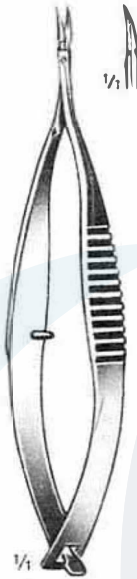

VANNAS
56-0645
curved
10CM



VANNAS
56-0646
angular
10CM

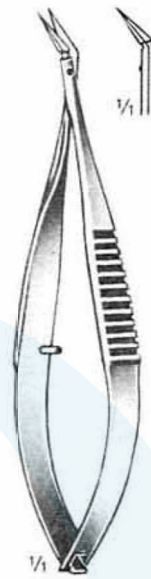

VANNAS
56-0647
angled up
10CM

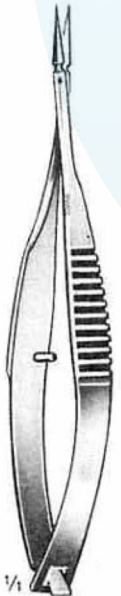

VANNAS
56-0648
straight
12CM



VANNAS
56-0649
curved
12CM

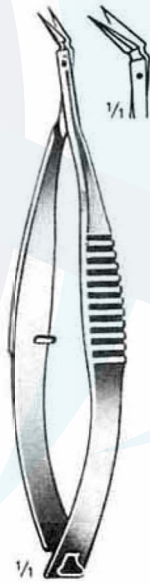

VANNAS
56-0650
angular
12CM



VANNAS
56-0651
angled up
12CM



MICRO SCISSOR
 56-0652 15CM
 56-0653 18CM
 56-0654 23CM
 straight



MICRO SCISSOR
 56-0655 15CM
 56-0656 18CM
 56-0657 23CM
 curved



MICRO SCISSOR
 56-0658 15CM
 56-0659 18CM
 56-0660 23CM
 straight



MICRO SCISSOR
 56-0661 15CM
 56-0662 18CM
 56-0663 23CM
 curved



56-0664 15CM
 56-0665 18CM
 56-0666 23CM
 Straight



56-0667 15CM
 56-0668 18CM
 56-0669 23CM
 CURVED



BARRAQUER
 6CM
 56-0670
 56-0671
 56-0672

MICRO SCISSORS, SPRING ACTION

Microciseaux a ressort
 Microtijeras con resorte
 Micro-Federschere



SCHULTZ MEDICAL™

56

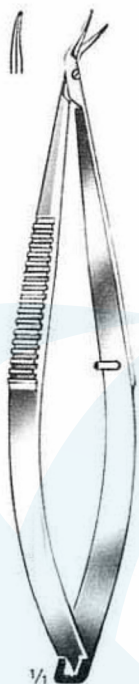

TROUTMAN
56-067' 10 cm
 left

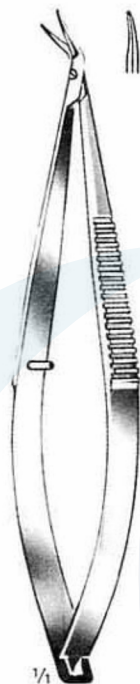

TROUTMAN
56-067 10 cm
 right

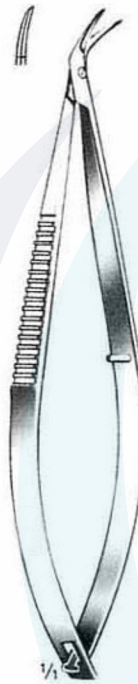

KATZIN
56-067 10 cm
 left

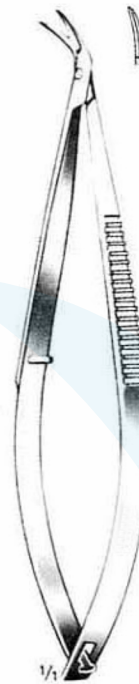

KATZIN
56-067* 10 cm
 right

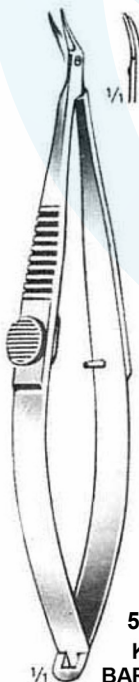

56-06++
KATZIN
BARRAQUER
 10 cm
 Right

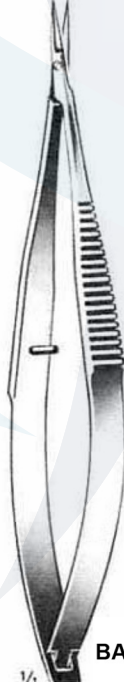

56-06+,
KATZIN
BARRAQUER
 10 cm
 Straight



56-06+-
KATZIN
BARRAQUER
 10 cm
 Curved

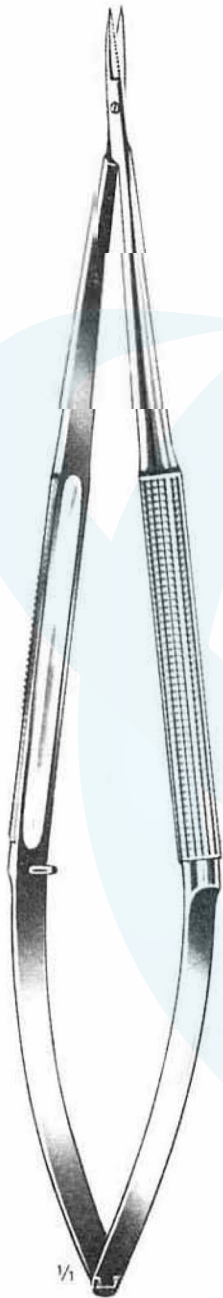

MICRO
56-0680
rotary handle
18 cm



MICRO
56-0681
rotary handle
18 cm



TERRY
56-0682 MICRO CORNEAL
SCISSOR



RICH
54-0683
CURVED
BLADES

EYE SCISSORS, SPRING ACTION

Ciseaux oculaires a ressort
Tijeras oculares con resorte
Augenfederscheren

56



IOL REMOVAL SCISSOR
56-0684 BLUNT TIP
8 MM LONG



IOL REMOVAL SCISSOR
56-0685 BLUNT TIP
8 MM LONG



CORNEAL SCISSOR
56-0686 CURVED
BLADES
10 MM LONG



CONJUNCTIVAL SCISSOR
56-0687 CURVED BLADES
11 MM LONG



CONJUNCTIVAL SCISSOR
56-0688 CURVED
08 MM LONG BLADES



CONJUNCTIVAL SCISSOR
56-0689 CURVED
10 MM LONG BLADES

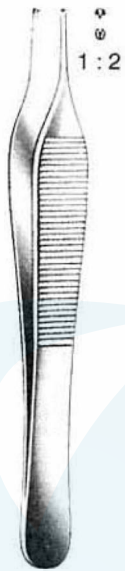

ADSON
 56-0690 12CM
 56-0691 15CM
 1x2 Teeth



MICRO-ADSON
 56-0692 12CM
 56-0693 15CM
 1x2 Teeth

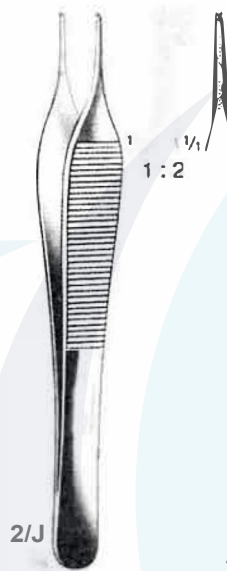

ADSON
 56-694 12 CM
 1x2 Teeth



ADSON
 56-0695 12 CM
 2x3 Teeth



ADSON-BROWN
 56-0696 12 CM
 7x7 Teeth



JEWELLERS
 56-0697
 12 CM



JEWELLERS
 56-0698
 12 CM



JEWELLERS
 56-0699
 12 CM



JEWELLERS
 56-0700
 12 CM

IRIS FORCEPS

Pinces a iris
Pinzas para iris
Irispinzetten

56



GRAEFE
56-0701 7cm
SERRATED



GRAEFE
56-0702 7cm
SERRATED



GRAEFE
56-0703 7cm
1*2 TEETH



GRAEFE
10 CM



56-0704
SERRATED



56-0705
SERRATED

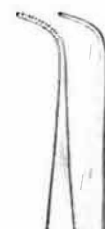

56-0706
SERRATED



56-0707
1x2 TEETH



56-0708
1x2 TEETH



56-0709
1x2 TEETH



1/2

STEVENS
11 cm
serrated



56-0710
STRAIGHT



56-0711
SEMI-CURVED



56-0712
CURVED



1/2

STEVENS
11 CM
1x2 teeth



56-0713
STRAIGHT



56-0714
SEMI-CURVED



56-0715
CURVED



MOD-BONN
56-0716 7 CM



MOD-BONN
56-0717 7 CM



ELLIOT
56-0718 10CM



STEVENS
56-0719 11 CM



STEVENS
56-0720 11 CM

IRIS FORCEPS

Pinces a iris
Pinzas para iris
Irispinzetten

56



HESS
56-0721
1x2 TEETH
10 CM

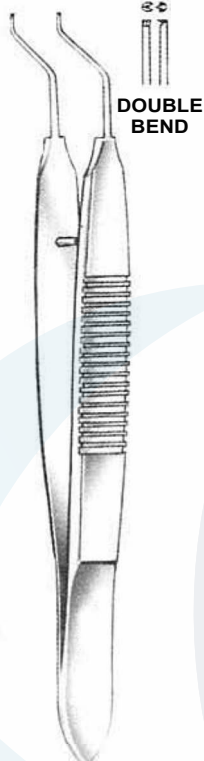

HESS
56-0722
1x2 TEETH
10 CM



FUCHS
56-0723
1x2 TEETH
7 CM

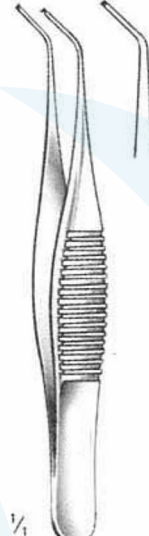

HESS
56-0724
1x2 TEETH
7 CM

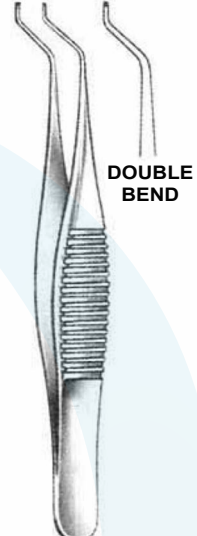

HESS
56-0725
1x2 TEETH
7CM



GILL
56-0726
1x2 Teeth
7CM

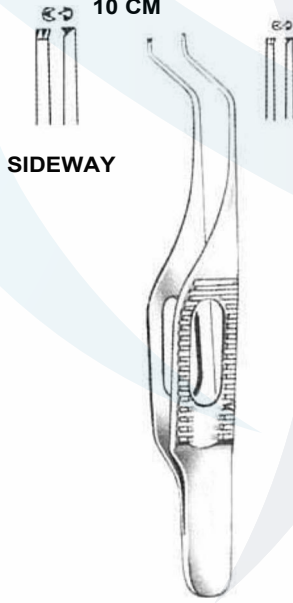

GILL HESS
56-0727
1x2 Teeth
7CM



FISCHER
56-0728
1x2 Teeth
7CM



FISCHER-ARLT
56-0729
1x2 Teeth
7CM

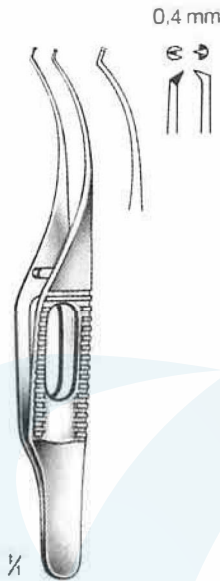

BARRAQUER 56-0730 (Colibri)
 Without tying platform
 1x2 teeth, 7 CM

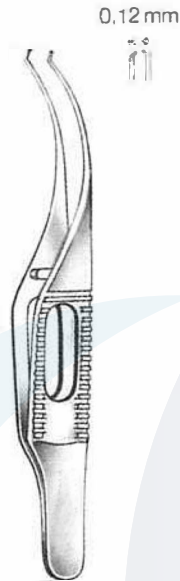

BARRAQUER 56-0731 (Colibri)
 With tying platform
 1x2 teeth, 7 CM

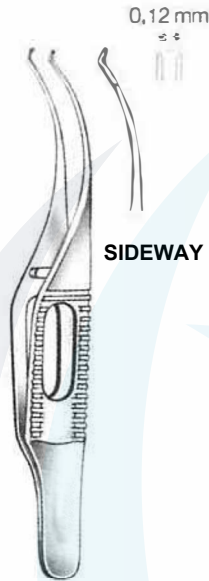

BARRAQUER 56-0732 (Colibri),
 With tying platform
 1x2 teeth, 7 CM

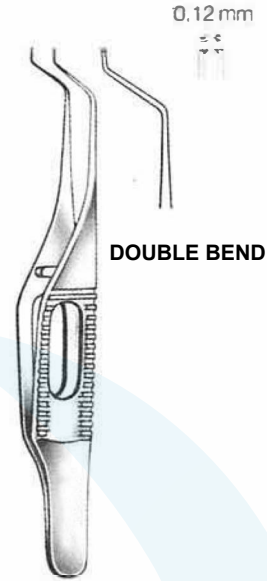

BARRAQUER 56-0733 (Colibri)
 With tying platform
 1x2 teeth, 7 CM

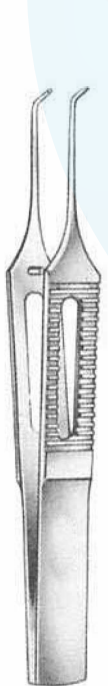

56-0734 PIERSE (Colibri)
 8CM
 Skeleton Forceps

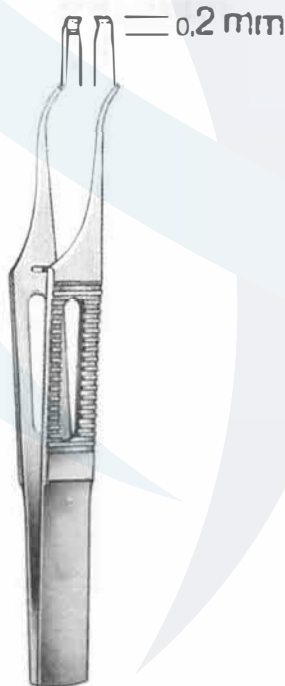

56-0735 PIERSE (Colibri)
 8CM
 Skeleton Forceps



56-0736 Skeleton Forceps
 Without Tying platform

56-0737 Suture Forceps
 With Tying platform

PIERSE 8CM



56-0738 BOTVIN SERRATED TIPS 1X2 TEETH

IRIS FORCEPS

Pincas a iris
Pinzas para iris
Irispinzetten

56

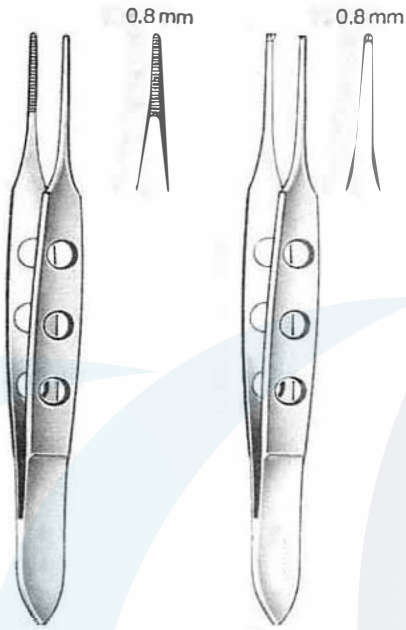

BISHOP HARMAN
56-0739
Serrated
9CM

BISHOP HARMAN
56-0740
1x2 teeth
9CM

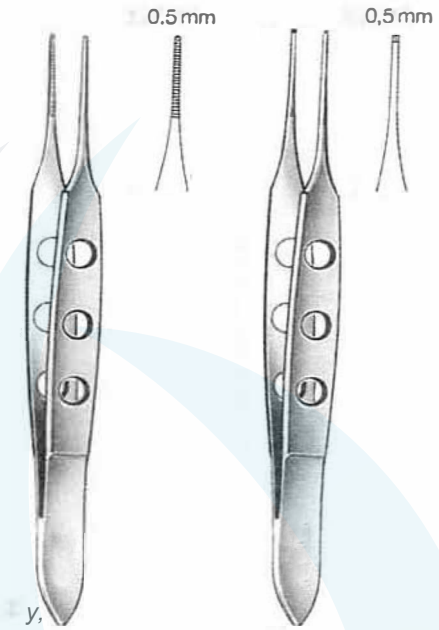

BISHOP HARMAN
56-0741
Serrated
9CM

BISHOP HARMAN
56-0742
1x2 teeth
9CM

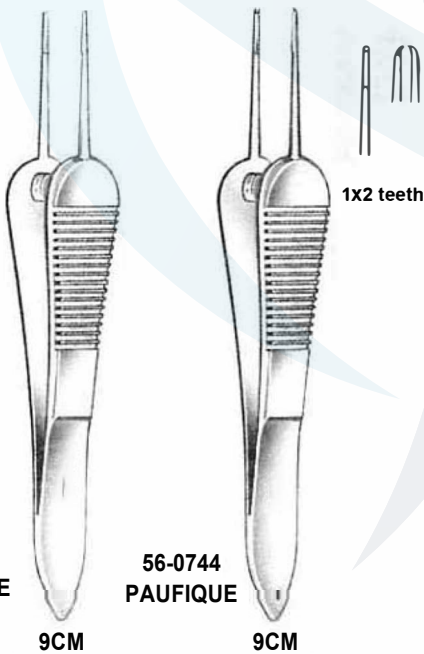

56-0743
PAUFIQUE
9CM

56-0744
PAUFIQUE
9CM

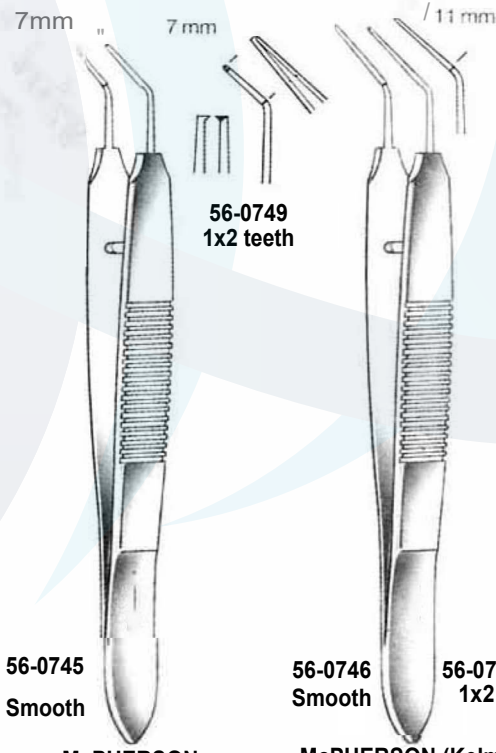

56-0745
Smooth

McPHERSON
10 cm

56-0749
1x2 teeth

56-0746
Smooth

McPHERSON (Kelman)
10 cm

56-0747
1x2



HOSKIN
56-0748 #16
FINE GROOVED
TIP

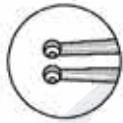

FECHTNER
56-0749 RING SHAPE
TIP



PIERSE
CORNEAL FORCEPS
56-0750 1X1 TEETH



HOSKIN
56-0751 #18 FINE GROOVED TIP
56-0752 #19 MICRO GROOVED TIP
56-0753 #28 VERY DELICATE



HOSKIN
56-0754 #22 MICRO GROOVED TIPS
56-0755 #30 VERY DELICATE TIPS
56-0756 #34 POINTED TIPS

56



THORPE
56-0757 2X3
TEETH 0.12MM



THORPE
56-0761 2X3
TEETH 0.12MM



**COLIBRI CORNEAL
FORCEPS**

56-0758
0.10MM 1X2
TITANIUM

56-0759
0.30 1X2
TITANIUM

56-0762
0.12 1X2
TITANIUM

56-0763
0.30 1X2
TITANIUM

56-0764
0.12 1X2
OBLIQUE TITANIUM

56-0765
0.30
NOTCHED TITANIUM



**CORNEAL
FORCEPS**



BONN CORNEAL FORCEPS
56-0760

STRAIGHT
0.12MM 1X2 TEETH

56-0766
0.10MM
TITANIUM

56-0767
0.30MM
TITANIUM

56-0768
0.10MM
OBLIQUE TITANIUM

56-0769
0.30MM
OBLIQUE TITANIUM



CORNEAL FORCEPS
56-0770 1X2 STRAIGHT
0.12MM TEETH

FORCEPS

Pinzas
Forceps
Forseps

56



IRIS FORCEPS
56-0771 1X2
STRAIGHT 0.20
MM TEETH



**CONJUNCTIVAL
FORCEPS**
56-0772 1X2
STRAIGHT 0.50MM
TEETH



SUTURING FORCEP
56-0773 0.12 MM
56-0774 0.35MM
56-0775 0.60MM
56-0776 0.90MM



SCLERAL FORCEPS
56-0777 1X2
STRAIGHT
0.70 MM TEETH



CORNEAL FORCEPS
56-0778
1X2 STRAIGHT
0.12 MM TEETH



56

JAYLE CORNEAL TYING FORCEPS

56-0779 0.15 MM TEETH

56-0780 0.30 MM TEETH

56-0781 0.15 MM TEETH TITANIUM

56-0782 0.30 MM TEETH TITANIUM



ST.MARTIN CORNEAL TYING FORCEPS

56-0783 0.15 MM TEETH

56-0784 0.30 MM TEETH

56-0785 0.15 MM TEETH TITANIUM

56-0786 0.30 MM TEETH TITANIUM



BONN MICRO TYING FORCEPS

56-0787 0.12 MM TEETH

56-0788 0.12 MM TEETH TITANIUM



BONN MICRO TYING FORCEPS

56-0789 IRIS 0.12 MM TEETH

56-0790 IRIS 0.12 MM TEETH TITANIUM

FORCEPS

Pinzas
Forceps
Forseps



**56-0791
MOODY
1X2 TEETH
0.5MM, WITH LOCK**



**56-0792
CASTROVIEJO
COLIBRI
0.12MM 1X2
TEETH**



**56-0793
GIRARD
0.12MM, 1X2
TEETH**



**56-0794
STERN-CASTROVIEJO
0.5MM, 1X2 TEETH
WITH LOCK**



**56-0795
BORES
1X2 TEETH
3 MM SPREAD, 0.12MM**



**DRESSING FORCEPS
SERRATED, DELICATE
56-0796 STRAIGHT
56-0797 CURVED**



**TISSUE FORCEPS
1X2 TEETH
56-0798 DELICATE, STRAIGHT
56-0799 DELICATE, CURVED
56-0800 STANDARD, STRAIGHT
56-0801 STANDARD, CURVED**

56



BAYONET
56-0802
20MM
LONG



KURSTIN
56-0806
FLAP STRETCHING FORCEPS
56-0807
LASIK FLAP FORCEPS



TROUTMAN
56-0803 1X2
TEETH ANGLED



MASKET
56-0804
CAPSULORRHESIS
FORCEPS



UTRATA
56-0805
CAPSULORRHESIS
FORCEPS



HABERLE-MCPHERSON
56-0808 7.5MM LONG JAWS



INAMURA
56-0809 **CAPSULORRHESIS**
FORCEPS



FORCEPS

Pinzas
Forceps
Forseps



KRAFF
56-0810 11MM
LONG SHANKS



UTRATA
56-0811
CAPSULORHEXIS
FORCEPS



UTRATA
56-0812
CAPSULORHEXIS
FORCEPS
VERY DELICATE



UTRATA
56-0813
CAPSULORHEXIS
FORCEPS
VERY DELICATE
ROUND HANDLE



NEVYAS
TEARING & GRASPING
56-0814 STAINLESS
STEEL
56-0815 TITANIUM



MASKET
VERY DELICATE
56-0816 STAINLESS
STEEL
56-0817 TITANIUM



INAMURA
CAPSULORHEXIS
56-0818
2 MM INCISION

56

56



MASKET
56-0819 STAINLESS
STEEL
56-0820 TITANIUM



CAPSULORHEXIS FORCEPS
56-0821 11 CM ANGLED
56-0822 12 CM ANGLED



CAPSULORHEXIS FORCEPS
56-0823 11CM
ROUND HANDLE CURVED



CAPSULORHEXIS
56-0824 11.5 CM
LONG CORYDON
FORCEPS



CAPSULORHEXIS FORCEPS
56-0825 11CM
ROUND HANDLE

FORCEPS

Pinzas
Forceps
Forseps

56



**CAPSULORHEXIS FORCEPS
56-0826 12 MM SHARP TIP
ANGLED TITANIUM**



**CAPSULORHEXIS FORCEPS
56-0827 11 MM NOTCHED
TIP ANGLED TITANIUM**



**CAPSULORHEXIS FORCEPS
56-0828 12 MM SHARP TIP
STRONG ANGLED TITANIUM**



**CAPSULORHEXIS FORCEPS
56-0829 11 MM SHARP TIP
STRONG ANGLED TITANIUM**

56



INAMURA CAPSULORHEXIS FORCEPS
56-0830 12 MM SHARP SERRATED
TIPS TITANIUM



CAPSULORHEXIS FORCEPS
56-0831 11 MM SLIGHTLY CURVED
ARMS SHARP NOTCHED TIPS



CAPSULORHEXIS FORCEPS
56-0832 11 MM SLIGHTLY CURVED
ARMS SHARP TIPS



CAPSULORHEXIS FORCEPS
56-0833 11 MM SHARP TIPS FLAT HANDLE

FORCEPS

Pinzas
Forceps
Forseps

56



MICS CAPSULORHEXIS
56-0834 2 MM OPENING
TITANIUM



CAPSULORHEXIS FORCEPS
56-0835 MICRO COAXIAL
PHACO TITANIUM



MICS/MCCS
CAPSULORHEXIS
56-0836 2 MM
OPENING TITANIUM



CAPSULORHEXIS FORCEPS
56-0837 EXTREMELY
DELICATE



PRECHOPPER
56-0838 COMBO
PRECHOPPER

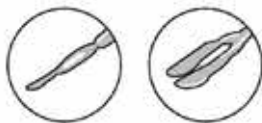

AKAHOSHI HYBRID
56-0840 COMBO
PRECHOPPER NUCLEUS 1
TO 4 GRADES



PRECHOPPER
56-0839 2 MM INCISION
NUCLEUS 1 TO 3 GRADES

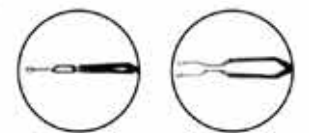

AKAHOSHI UNIVERSAL
56-0841 NUCLEUS
SPLITTER

56



AKAHOSHI
56-0842 4.5 MM
LONG DELICATE
JAWS



AKAHOSHI
56-0843
COMBO
PRECHOPPER



ANIS
56-0844
STRAIGHT
56-0845
CURVED

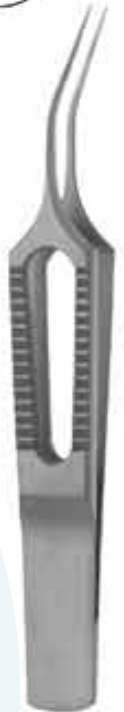

GERL
56-0846
6 MM LONG
PLATFORM
TITANIUM

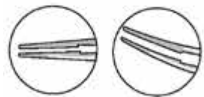

TENNANT
TYING FORCEPS
56-0847 STRAIGHT S.S
56-0848 CURVED S.S
56-0849 STRAIGHT TITANIUM
56-0850 CURVED TITANIUM

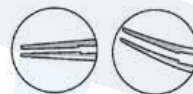

JAFFE
TYING FORCEPS
56-0851 STRAIGHT S.S
56-0852 CURVED S.S
56-0853 STRAIGHT TITANIUM
56-0854 CURVED TITANIUM



FREEMAN - JAFFE
56-0855 LENS
HOLDING FORCEPS

FORCEPS

Pinzas
Forceps
Forseps



Jaws Cross Section

56-0856 STRAIGHT S.S
56-0857 STRAIGHT
TITANIUM
56-0858 CURVED S.S
56-0859 CURVED
TITANIUM



56-0860 4MM STRAIGHT
56-0861 4MM CURVED
56-0862 4MM ANGLED
56-0863 8MM ANGLED



56-0864 S.S
56-0865 TITANIUM



56-0866 S.S
56-0867
TITANIUM

56

MAUMENEE
TYING FORCEPS



56-0868 STRAIGHT S.S
56-0869 STRAIGHT
TITANIUM
56-0870 CURVED S.S
56-0871 CURVED
TITANIUM

HARMS TYING FORCEPS

MCPHERSON
TYING FORCEPS



56-0872 11 MM TYING
56-0873 07 MM TYING

KELMANN FORCEPS

TUEBINGEN
MODEL CURVED



TROUTMANN FORCEPS

TUEBINGEN
MODEL
STRAIGHT



56-0874 7MM STRAIGHT
56-0875 7 MM CURVED

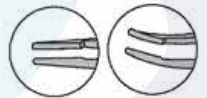

56



56-0876
TROUTMANN
FORCEPS
STRAIGHT, BULLET
SHAPE



56-0877
TROUTMANN
FORCEPS
CURVED, BULLET
SHAPE



56-0878
IOL LOADING FORCEPS
11 MM TIP ANGLED
TITANIUM



GOLF BALL TYING FORCEPS
56-0879 08 MM ANGLED
56-0880 05 MM ANGLED
56-0881 05 MM STRAIGHT
56-0882 05 MM DELICATE
STRAIGHT TITANIUM

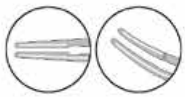
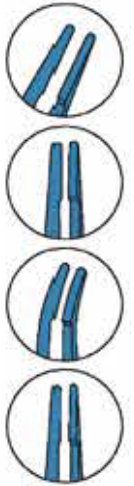

TYING FORCEPS
56-0883 STRAIGHT
56-0884 CURVED



MCPHERSON FORCEPS
56-0885 5 MM STRAIGHT
56-0886 5 MM ANGLED
56-0887 10 MM ANGLED

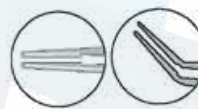

KELMAN MCPHERSON
56-0888 11 MM ANGLED

FORCEPS

Pinzas
Forceps
Forseps

56



FIXATION FORCEPS
56-0889 3MM
56-0890 4MM



**56-0891 GREEN
FIXATION FORCEPS**



FINE
56-0892
7-0 TO 9-0
SUTURES



CILIA FORCEPS
56-0893 S.S
56-0894
TITANIUM



**56-0895
BEER FORCEPS**



ARITA
56-0896
POLISHED
JAWS



HELVESTON
56-0897
4-0 TO 6-0
SUTURES



**56-0898
BARRAQUER
CILIA FORCEPS**

56



BARRAQUER
56-0899 CILIA
FORCEPS



GRADLE
56-0900
SMOOTH
JAWS

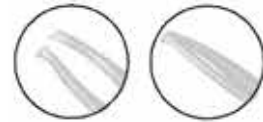

GIANNETTI
56-0901 1.75 MM
JAWS OPENING



56-0902
CILIA FORCEPS
GOLD PLATED
JAWS



BONACCOLTO
56-0903 1.2 MM WIDE
56-0904 1.7 MM WIDE

FORCEPS

Pinzas
Forceps
Forseps

56



**MOORFIELDS CONJUNCTIVAL
FORCEPS**

56-0905 FINE S.S
56-0906 STANDARD TITANIUM
56-0907 FINE TITANIUM

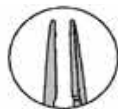

**56-0908
STALLARD
TYING FORCEPS**

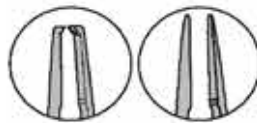

**RYCROFT CORNEAL
56-0909 PLAIN
56-0910 0.30 MM
TEETH**



**56-0911
SCLERAL PLUG**

**UTILITY & SPLINTER
56-0912 SHORT JAWS**



**FOREIGN
56-0913
STRAIGHT**



56



MICRO FORCEPS, 15 CM
56-0914 6MM TYING STRAIGHT
56-0915 6MM TYING CURVED



NUGENT
56-0916 SMOOTH JAWS
56-0917 SERRATED JAWS



VESSEL DILATOR
56-0918 11 CM LONG



JEWELERS
56-0919
STANDARD
STRAIGHT # 1

FORCEPS

Pinzas
Forceps
Forseps

56



**JEWELERS
56-0920
DELICATE
STRAIGHT # 3-C**



**JEWELERS
56-0921
DELICATE
STRAIGHT # 3**



**JEWELERS
56-0922
DELICATE
STRAIGHT # 4**



**JEWELERS
56-0923
EXTRA
DELICATE
STRAIGHT # 5**



**OSHER
56-0924
FINE JAWS**



**JEWELERS
56-0925 EXTRA
DELICATE,
ANGLED
#5/45**



**JEWELERS
56-0926
CURVED
#7**



56



**SUTURE
56-0927
REMOVAL
FORCEPS**



**JAFFE
56-0928
UTILITY
FORCEPS**



**ERNEST
56-0929
SERRATED
PADDLE TIPS
2.5MM
INCISION**



**ERNEST
56-0930
SERRATED
PADDLE TIPS
2.5MM
INCISION**



**56-0931
IMPLANTATION
FORCEPS**



**56-0932
RIGID IOL
IMPLANTATION
FORCEPS**



**56-0933
ARRUGA
CAPSULE
FORCEPS**

FORCEPS

Pinzas
Forceps
Forseps

56



**56-0934
DODICK
CROSS ACTION**



**56-0935
HU FEMTO FORCEPS
0.3 MM
BLUNTED TIPS**



**56-0936
ALFONSO
DELICATE
INTERLOCKING
TEETH**



**56-0937
COAXIAL
FORCEPS**



**56-0938
CORNEAL
SCLERAL PUNCH
STRAIGHT Ø1.5 MM**

56



56-0939
STRIPPING FORCEPS
STRAIGHT



56-0940
STRIPPING FORCEPS
CURVED TIP



56-0941
DODICK
IOL
FOLDING
FORCEPS



56-0942
LIVERNOIS
CONCAVE
JAWS



56-0943
FAULKNER
LENS
HOLDING
FORCEPS



56-0944
BURATTO
SOFT IOL
INSERTING
FORCEPS
EXTRA
DELICATE
JAWS



56-0945
SPALECK
SOFT IOL
INSERTING
FORCEPS
DELICATE
JAWS



FORCEPS

Pinzas
Forceps
Forseps

56



BECHERT
56-0946
LENS
HOLDING
FORCEPS



SHEPARD
56-0947
DUCKBILL
SHAPE JAWS



BLAYDES
56-0948
NARROW JAWS
45 ANGLE



56-0949
ERNEST -MCDONALD
BI-CONVEX JAWS



BERKE
56-0950 20 MM LONG
56-0951 27 MM LONG



56-0952
CLAYMAN
LENS
HOLDING
FORCEPS

56-0953
4 TEETH,
CHILD SIZE,
RIGHT

56-0954
4 TEETH,
CHILD SIZE,
LEFT



JAMESON

56-0955
6 TEETH, ADULT
SIZE, RIGHT
56-0956
6 TEETH, ADULTS
SIZE, LEFT

56



**LIVERNOIS IOL
HOLDING
FORCEPS**

**56-0957
ANGLED**

**56-0958
STRAIGHT**



**56-0959
STEINERT
IOL INSERTING
FORCEPS**



**LIVERNOIS-MCDONALD
56-0960 5MM LONG
CONCAVE JAWS**



**ERNEST-MCDONALD
56-0961 5MM LONG
STRAIGHT JAWS**

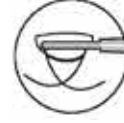

**56-0962
ERNEST-MCDONALD II
20 GAUGE JAWS**



**56-0965 WATZKE
SLEEVE
SPREADING
FORCEPS**



**MOORFIELD FORCEPS
56-0963 STANDARD
56-0964 MICRO**



**MOORFIELD
DRESSING FORCEPS
56-0966 STANDARD
56-0967 MICRO**

FORCEPS

Pinzas
Forceps
Forseps

56



IRIS FORCEPS
56-0968 STRAIGHT
56-0969 CURVED
56-0970 STRAIGHT TEETH 1X2
56-0971 CURVED TEETH 1X2



ST MARTIN FORCEPS
56-0972 WITH TYING 1X2
56-0973 PLAIN TYING



**BISHOP HARMON
FORCEPS**
56-0974
SERRATED

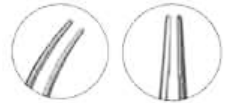

**TUEBINGEN TYING
FORCEPS**
56-0975 STRAIGHT
56-0976 CURVED

56



MCPHERSON FORCEPS
56-0977 STRAIGHT 5 MM TYING .
56-0978 ANGLED 5 MM TYING



**CASTROVIEJO
SUTURING
FORCEPS**
56-0979 0.3MM
1X2
56-0980 0.8MM
1X2



BONN FORCEPS
56-0981 0.12 MM 1 X 2



**KELMAN MCPHERSON
FORCEPS**
56-0982 ANGLED 8 MM
TYING
56-0983 ANGLED 10 MM
TYING

FORCEPS

Pinzas
Forceps
Forseps



**COLIBRI TYING
FORCEPS**
56-0984 0.12MM
1 X 2



**CORNEAL FINE
NOTCHED FORCEPS**
56-0986 0.2 MM
NOTCH



**COLIBRI FORCEPS
NOTCHED
56-990 FINE
GROOVE**



**JAYLE CORNEAL
TYING FORCEPS**
56-0988 1X2 0.3MM
56-0989 1X2 0.5MM

**UTRATA CAPSULORHEXIS
FORCEPS**
56-0985 LONG SHANKS

**CURVED CAPSULORHEXIS
FORCEPS**
56-0987 LONG SHANKS

56

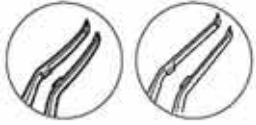

**ROUND CAPSULORHEXIS
FORCEPS**
56-0990 14 MM ANGLE
LENGTH



**56-0991
LENS
INSERTION
FORCEP**



**56-0992
BARRAQUER
CILIA FORCEP**



**BURATTO DISC
SHAPED**
56-0993 STRAIGHT
56-0994 CURVED



**56-0995
LASIK FLAP
FORCEP**



**56-0996
BEER
FORCEP CILIA**

IRIS FORCEPS

Pincas a iris

Pinzas para iris

Irispinzetten



SCHULTZ MEDICAL™

56

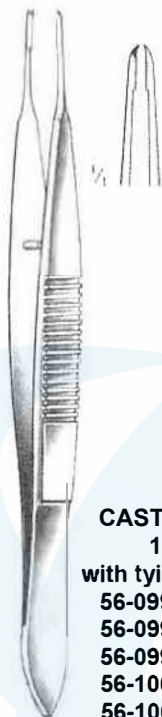

CASTROVIEJO
10 cm.
with tying platform
56-0997 0.2MM
56-0998 0.3MM
56-0999 0.5MM
56-1000 0.9MM
56-1001 1.5MM



CASTROVIEJO
10 cm. with tying platform
56-1002 0.5MM
56-1003 0.9MM
56-1004 1.5MM

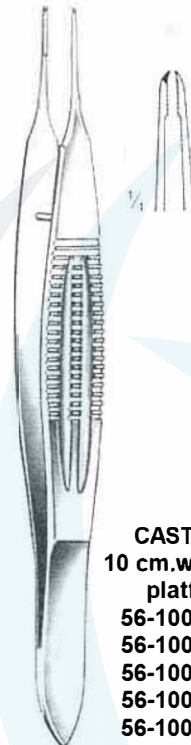

CASTROVIEJO
10 cm. with tying platform
56-1005 0.2MM
56-1006 0.3MM
56-1007 0.5MM
56-1008 0.9MM
56-1009 1.5MM



CASTROVIEJO
10 cm. with tying platform
56-1010 1.0MM

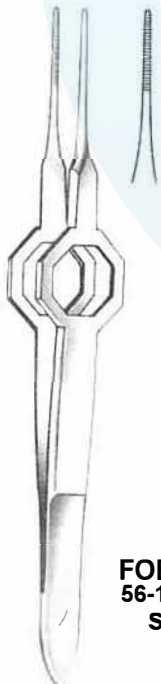

FOERSTER
56-1011 10 cm
Serrated



FOERSTER
56-1012 10cm
Serrated



FOERSTER
56-1013 10cm
1x2 teeth



FOERSTER
56-1014 10cm
1x2 teeth

56

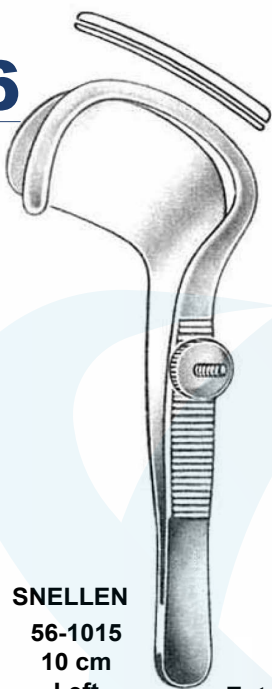

SNELLEN
56-1015
10 cm
Left

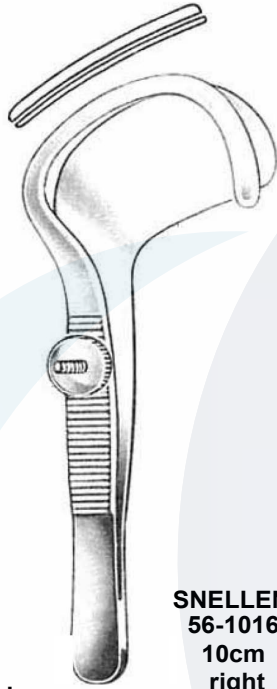

SNELLEN
56-1016
10cm
right

Entropium
Forceps

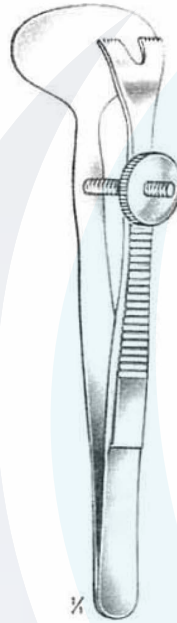

ERHARDT
56-1017 9cm

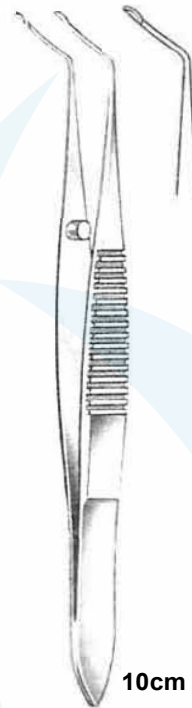

KALT
56-1018

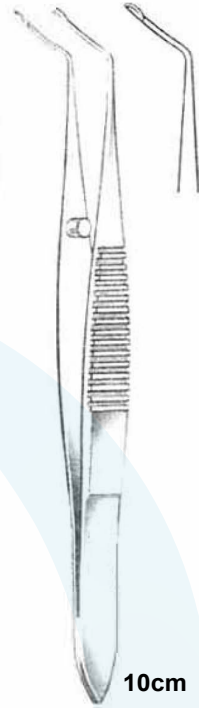

KALT
56-1019

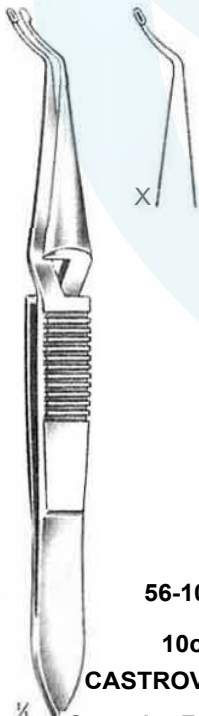

56-1020
10cm

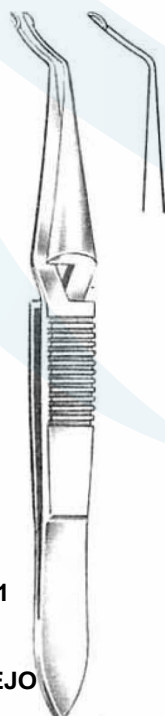

56-1021
10cm

CASTROVIEJO
Capsular Forceps



56-1022
ARRUGA
10cm



56-1023
ARRUGA
10cm



56-1024
ARRUGA
10cm

Capsular Forceps

IRIS FORCEPS

Pincas a iris
Pinzas para iris
Irispinzetten

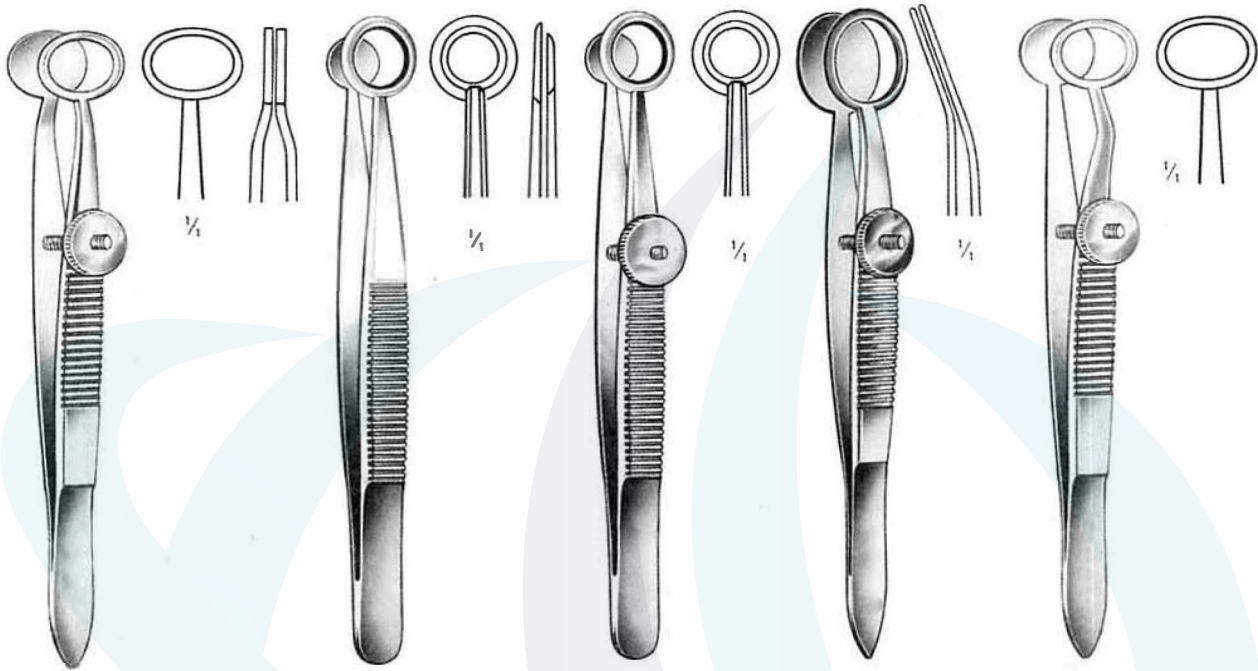

BAIRD
56-1025 10cm
Chalazion
Forceps

AYER
56-1026 10cm

AYER
56-1027 10cm

HUNT
56-1028 10cm

FRANCIS
56-1029 10cm

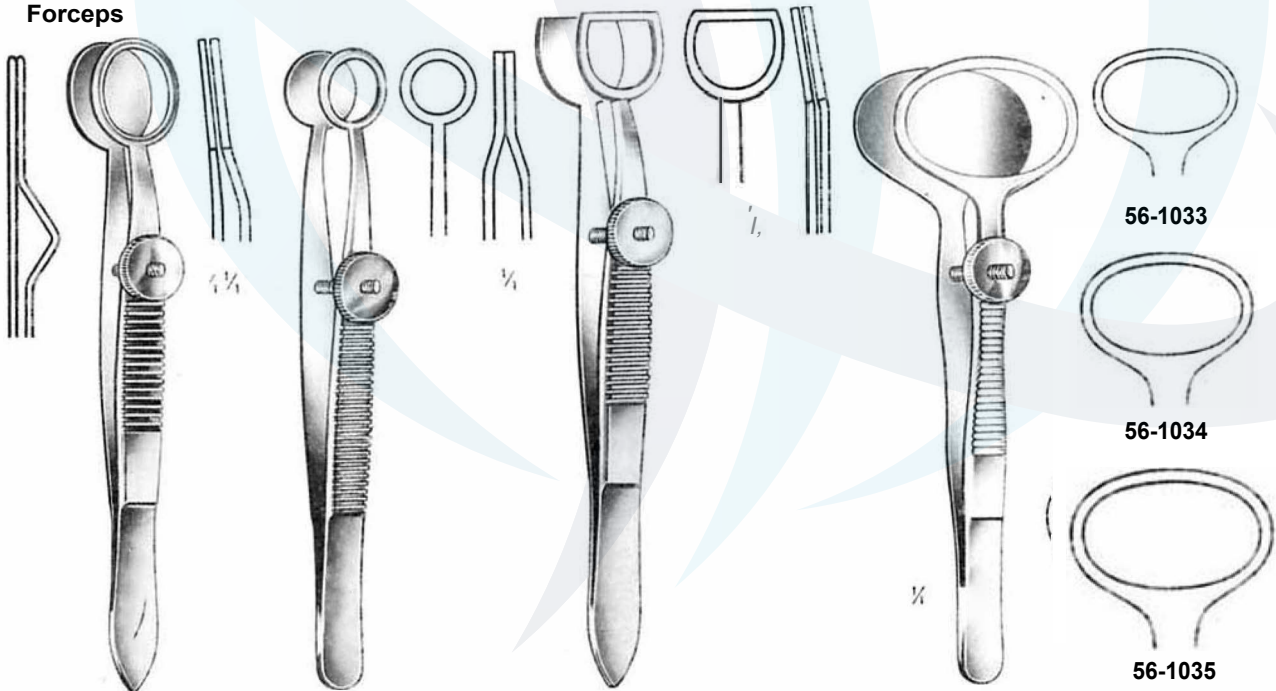

HEALTH
56-1030 10cm

LAMBERT
56-1031 10cm

WIES
56-1032 10cm

DESMARRES
10CM

56-1033

56-1034

56-1035

56

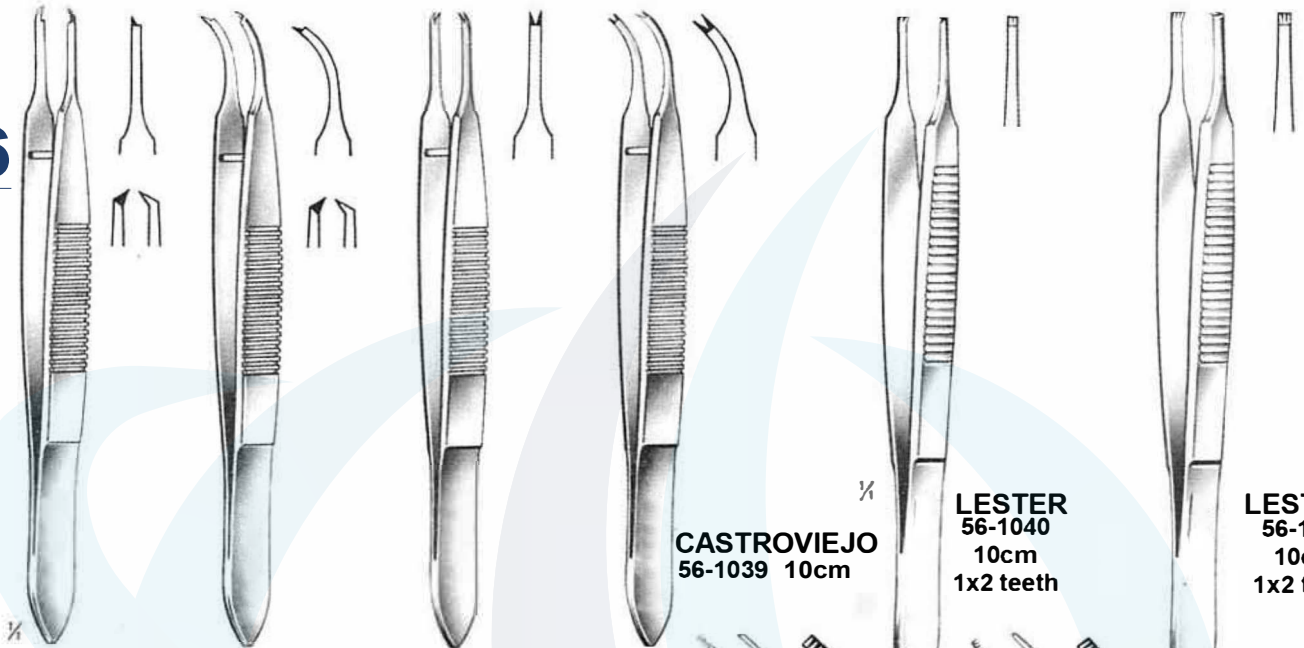

CASTROVIEJO 56-1036 10cm
Fixation Forceps

CASTROVIEJO 56-1037
10cm

CASTROVIEJO 56-1038 10cm

CASTROVIEJO 56-1039 10cm

LESTER 56-1040
10cm
1x2 teeth

LESTER 56-1041
10cm
1x2 teeth

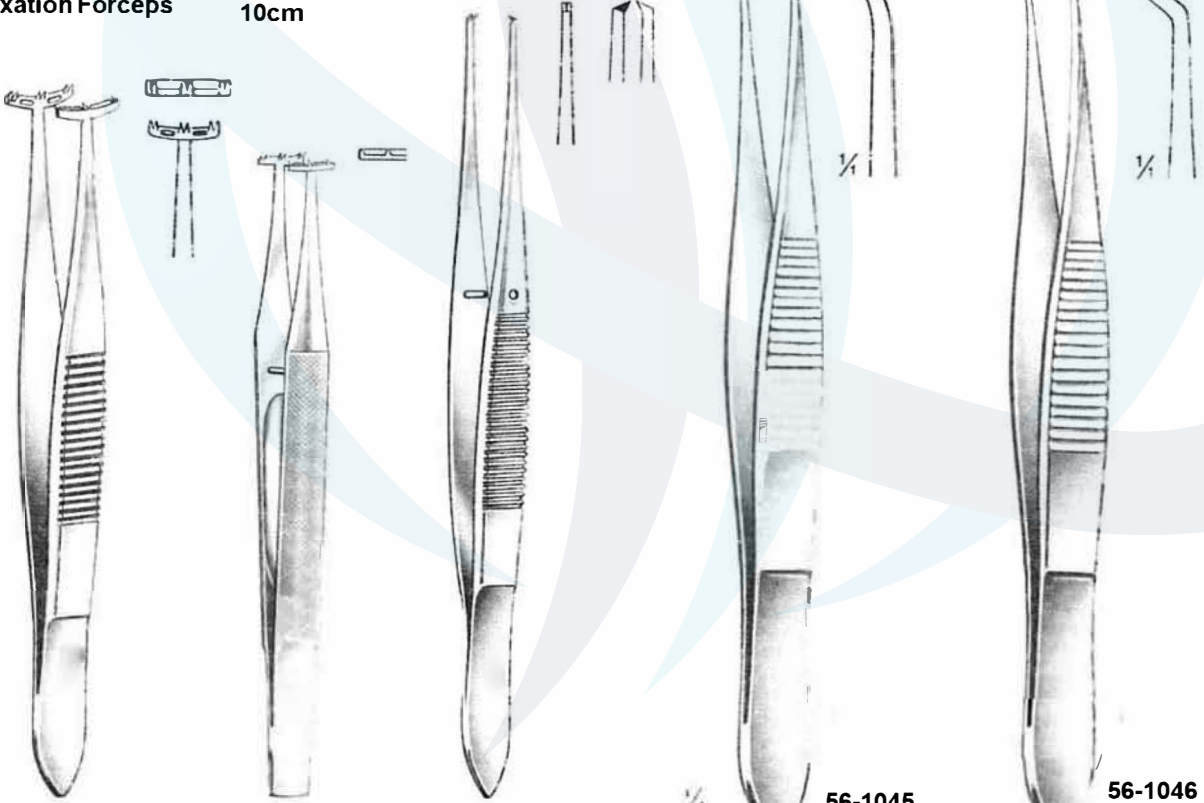

BARRAQUER 56-1042 10cm

BARRAQUER 56-1043 10cm

ELSCHMIG 56-1044 10cm

SCHWEIGGER 56-1045 10cm

SCHWEIGGER 56-1046 10cm

IRIS FORCEPS

Pinces a iris
Pinzas para iris
Irispinzetten



TUBINGEN
56-1047 10cm
Suture Forceps



BARRAQUER
56-1048
10 cm

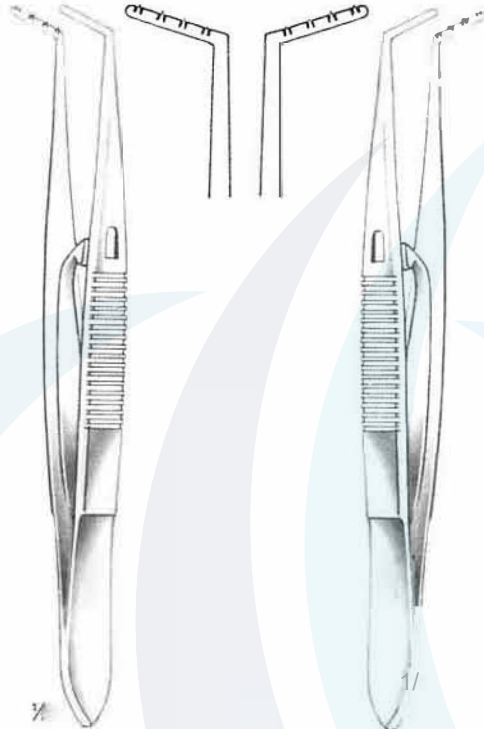

McPHERSON
56-1049 10cm
Straight

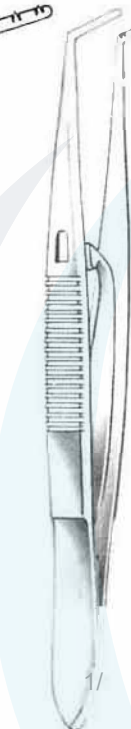

McPHERSON
56-1050
10cm
Curved

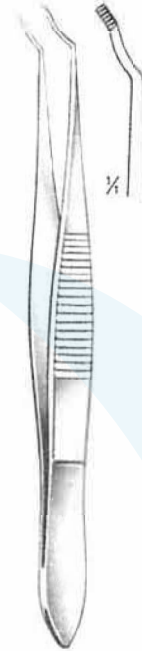

McPHERSON
56-1051
10cm
Straight

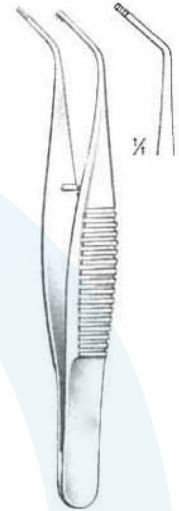

McPHERSON
56-1052
10cm
Curved

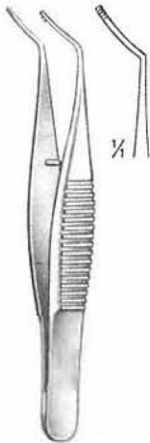

TERSON
56-1053 10cm

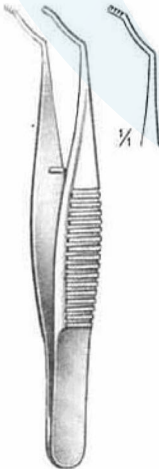

FUCHS
56-1054 8cm

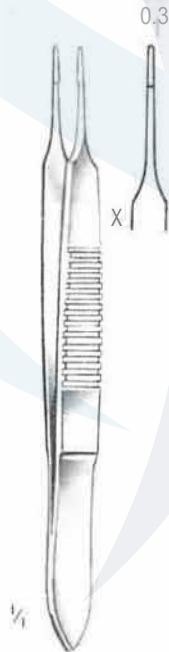

HESS
56-1055 7cm



HESS
56-1056 7cm

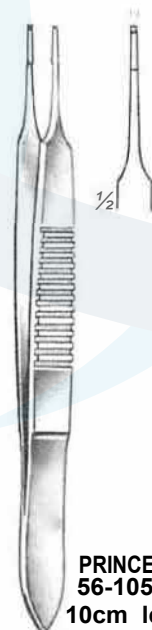

PRINCE
56-1057
10cm left



PRINCE
56-1058
10cm right

Muscular Forceps

56

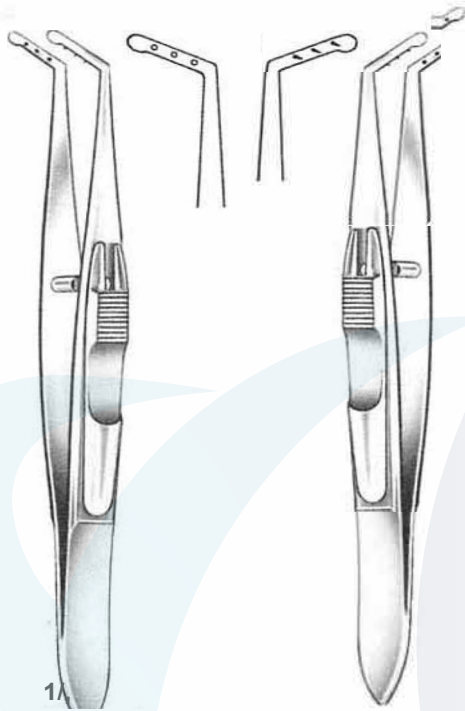

SATTLER
56-1059 10cm
left
Muscular Forceps

SATTLER
56-1060 10cm
right
Muscular Forceps

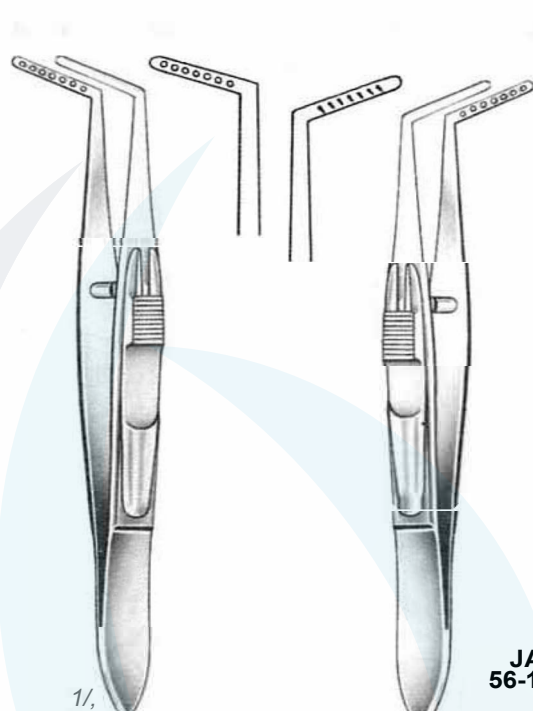

JAMESON
56-1061 10cm
left
Strabismus
Forceps

JAMESON
56-1062 10 cm
right
Strabismus
Forceps

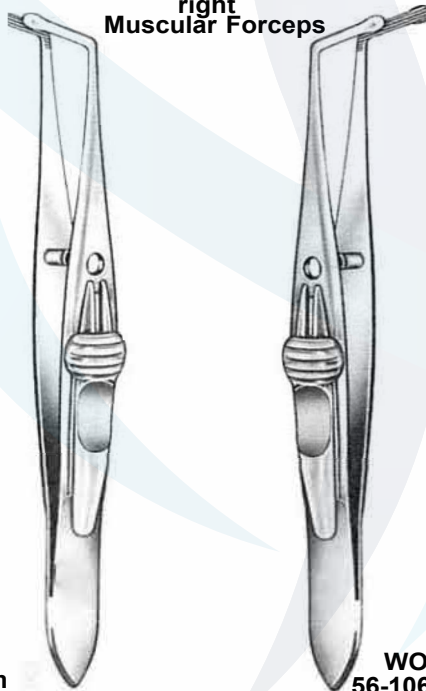

WORTH
56-1063 10 cm
left

Advancement Forceps

WORTH
56-1064 10cm
right

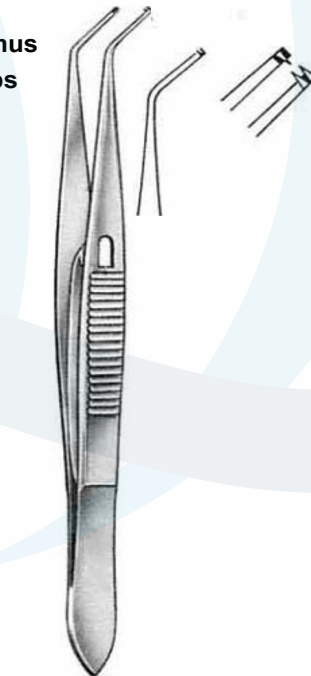

O'CONNOR
56-1065 10cm
Conjunctiva!
Forceps

IRIS FORCEPS

Pinces a iris
Pinzas para iris
Irispinzetten



BONACCOLTO
56-1066 10cm
Narrow jaws
Strabismus Forceps

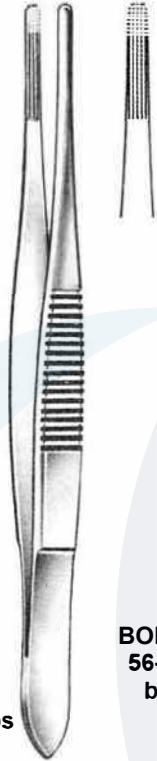

BONACCOLTO
56-1067 10cm
broad jaws



McCULLOUGH
56-1068 10cm

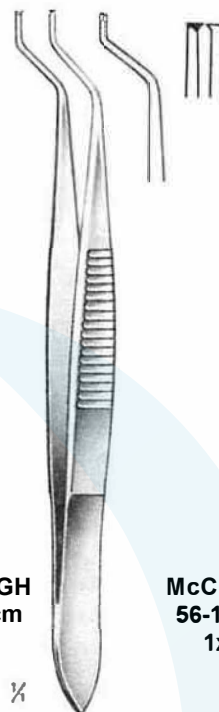

McCULLOUGH
56-1069 10cm
1x2 teeth



DASTOOR
56-1070 10cm
1x2 teeth



ELSCHNIG
56-1071 10cm
Fixation and
Grasping Forceps



GREEN
56-1072 10cm
Fixation
Grasping Forceps



GREEN
56-1073 10cm
Fixation
Grasping Forceps

56

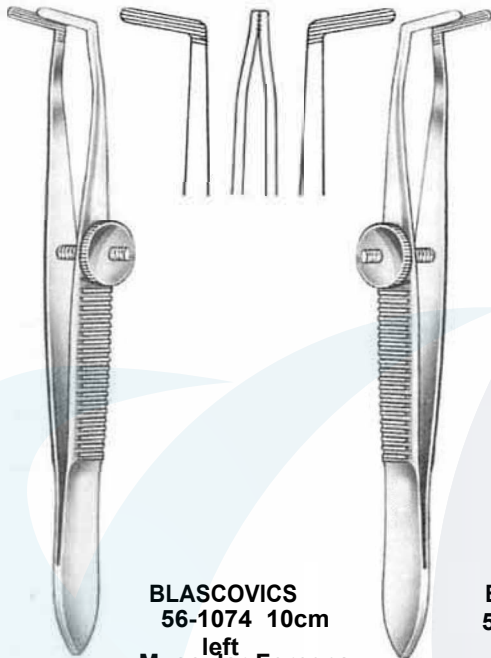

BLASCOVICS
56-1074 10cm
left
Muscular Forceps

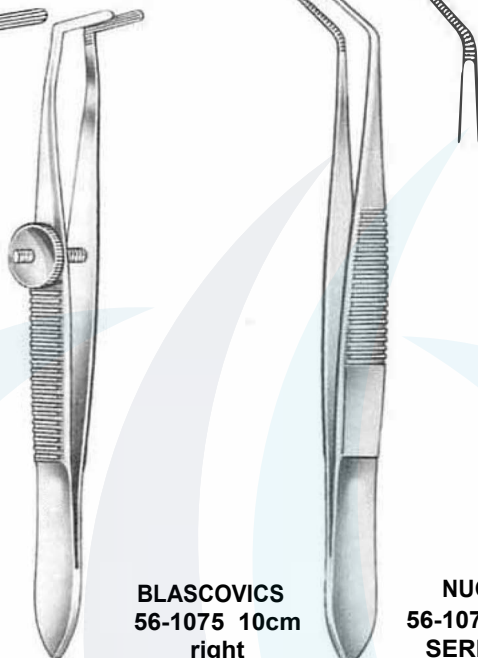

BLASCOVICS
56-1075 10cm
right

NUGENT
56-1076 10cm
SERRATED
Strabismus Forceps



NUGENT
56-1077
SMOOTH
10cm



ELSCHING

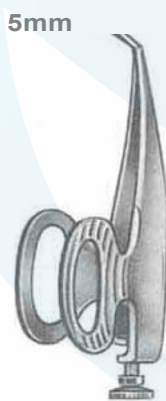

BARRAQUER
56-1078 6cm
Anterior Chamber
Forceps

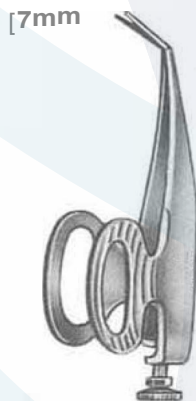

BARRAQUER
56-1079 6cm

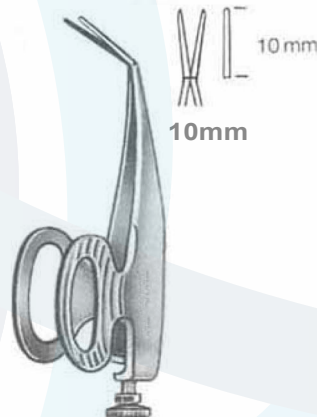

BARRAQUER
56-1080 11cm



SCHULTZ MEDICAL (UK) LIMITED

Unit 6, Commerce Park, Crowland Street, Southport,
PR9 7RL United Kingdom
www.schultzmedical.co.uk
info@schultzmedical.co.uk
Tel. +44 1772 250 298

4 5 Rockefeller Plaza 20th
Floor New York
NY10111, USA
info@schultz-medical.com
Tel. +1 212-332-3215

Alt-Heerdt 104
40549 Dusseldorf Germany
Info@schultz-medical.com
